

**Bri**  **pando**

**[brixpando.com](http://brixpando.com)**

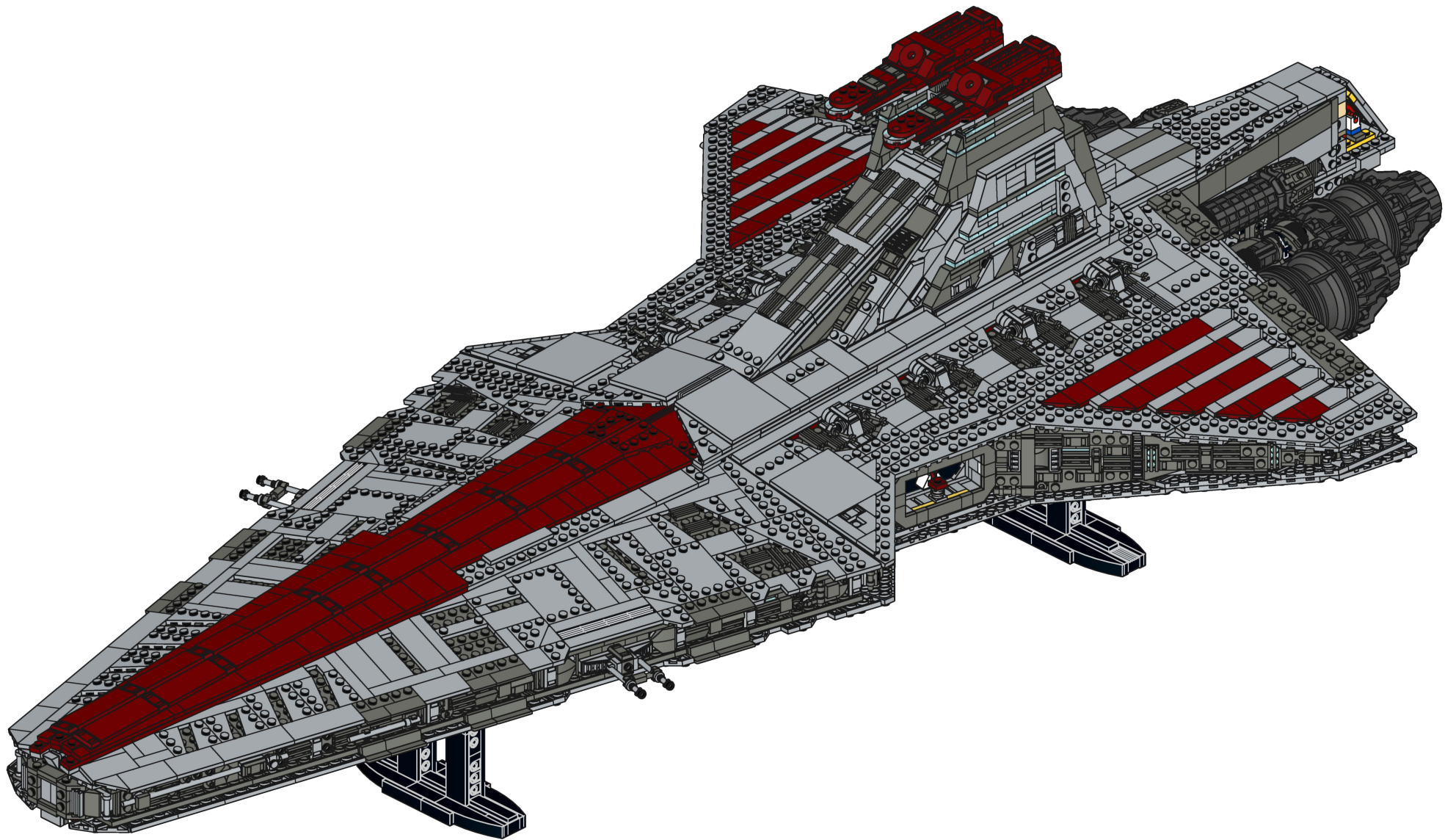

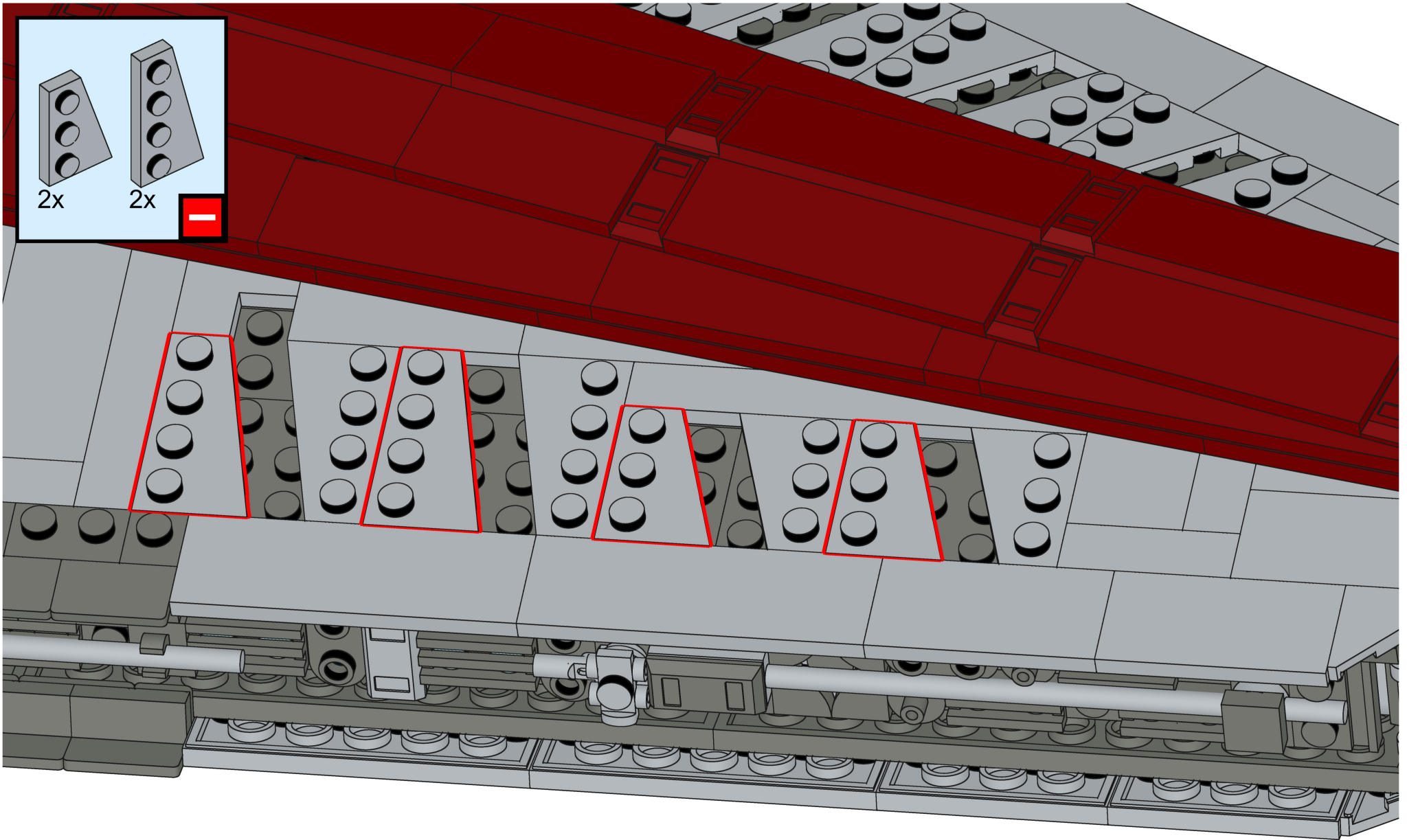

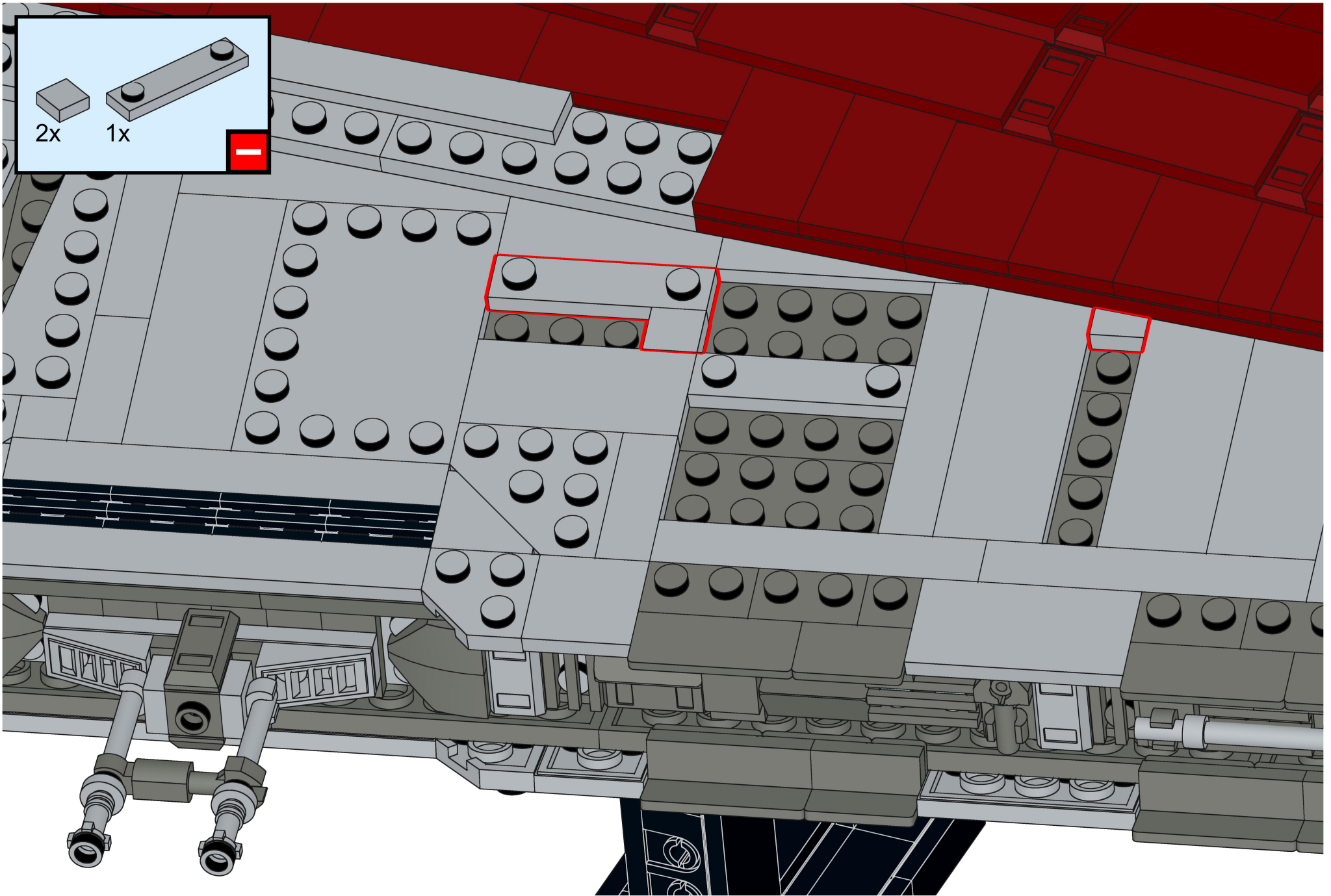

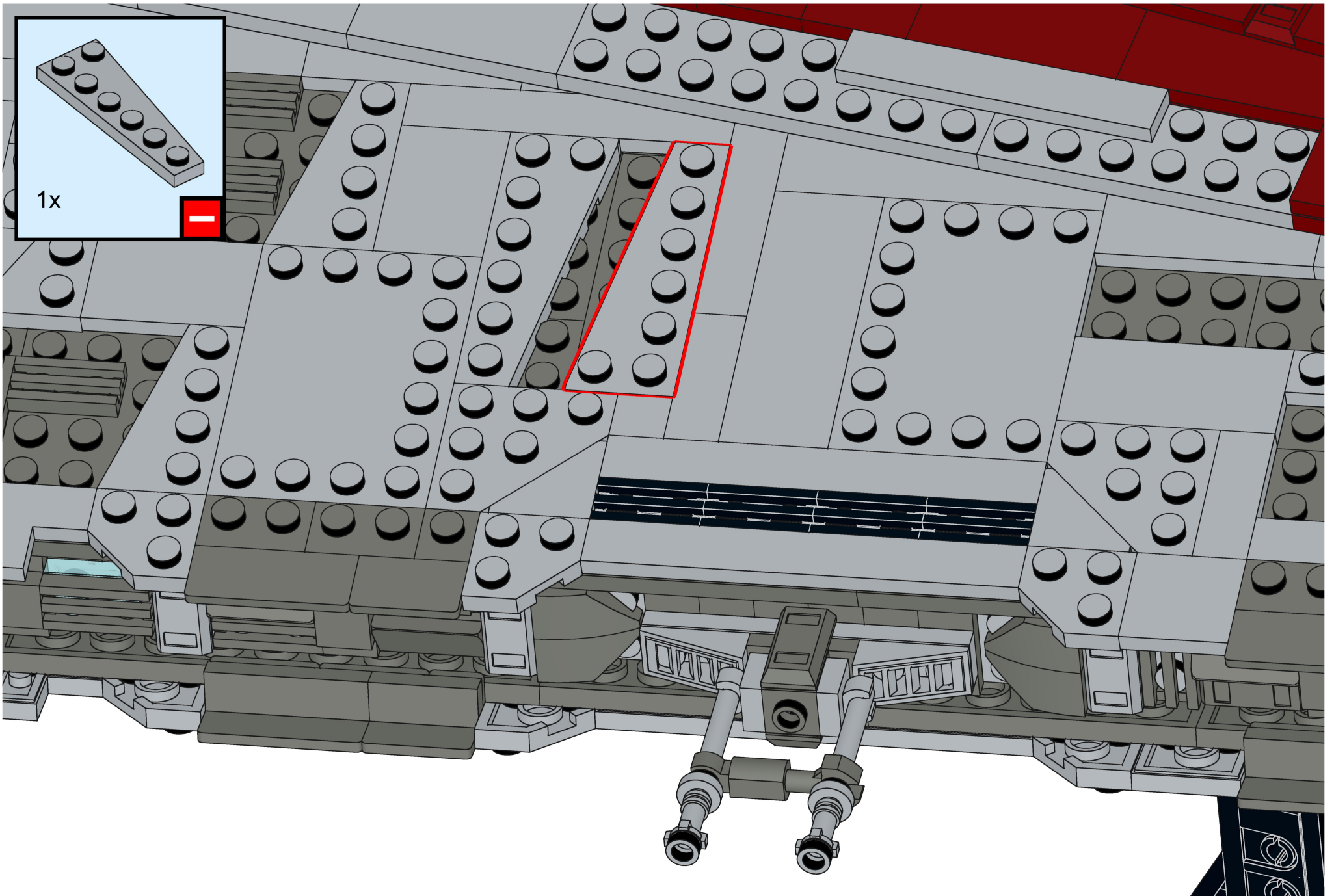

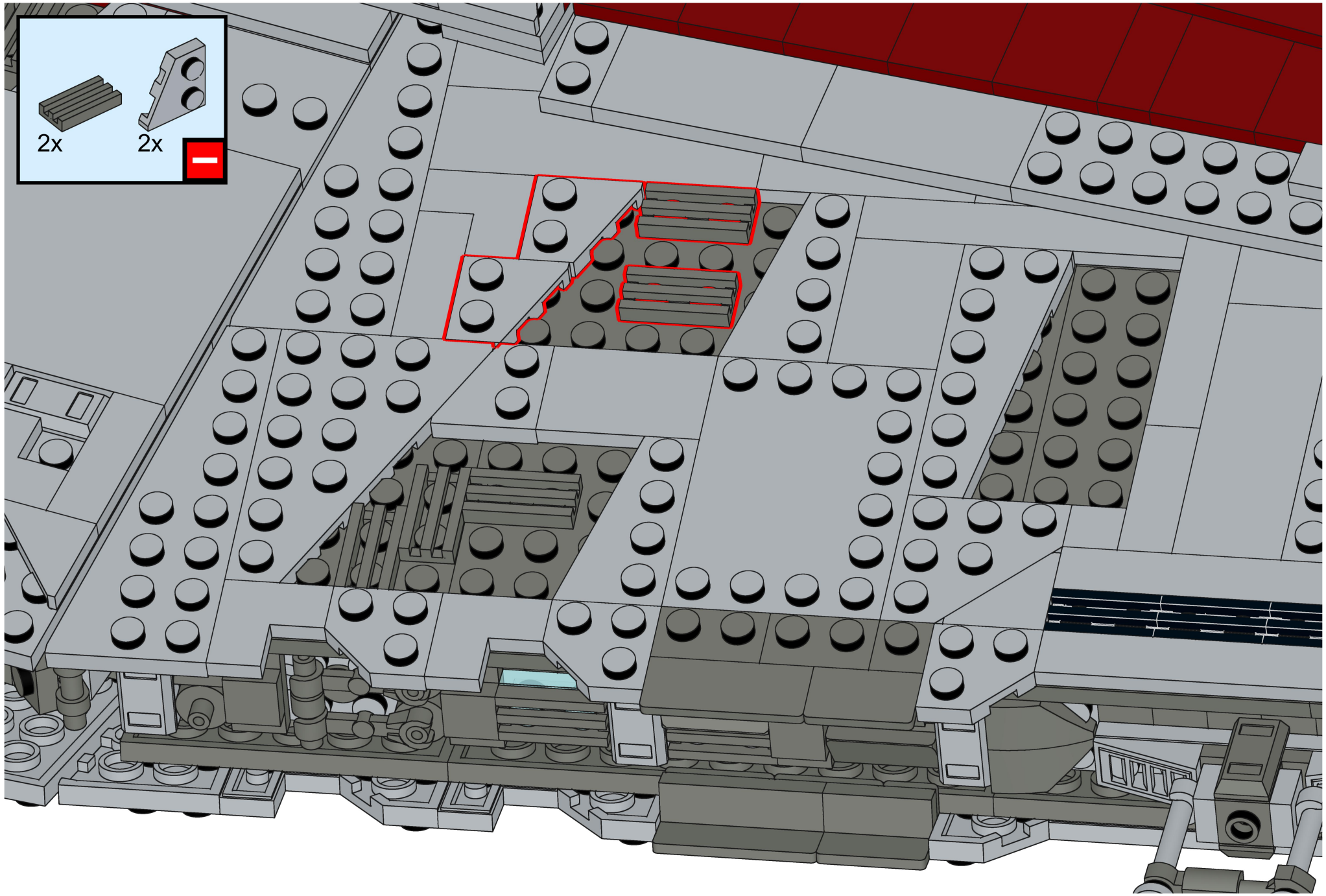



2x

2x

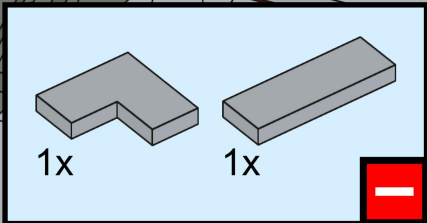
—

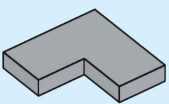
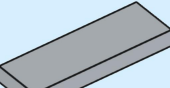

1x  1x 



This inset box lists the parts required for the assembly step. It includes one L-shaped Technic brick (1x4 holes), one 1x4 Technic brick, and one red Technic brick with a white notch.

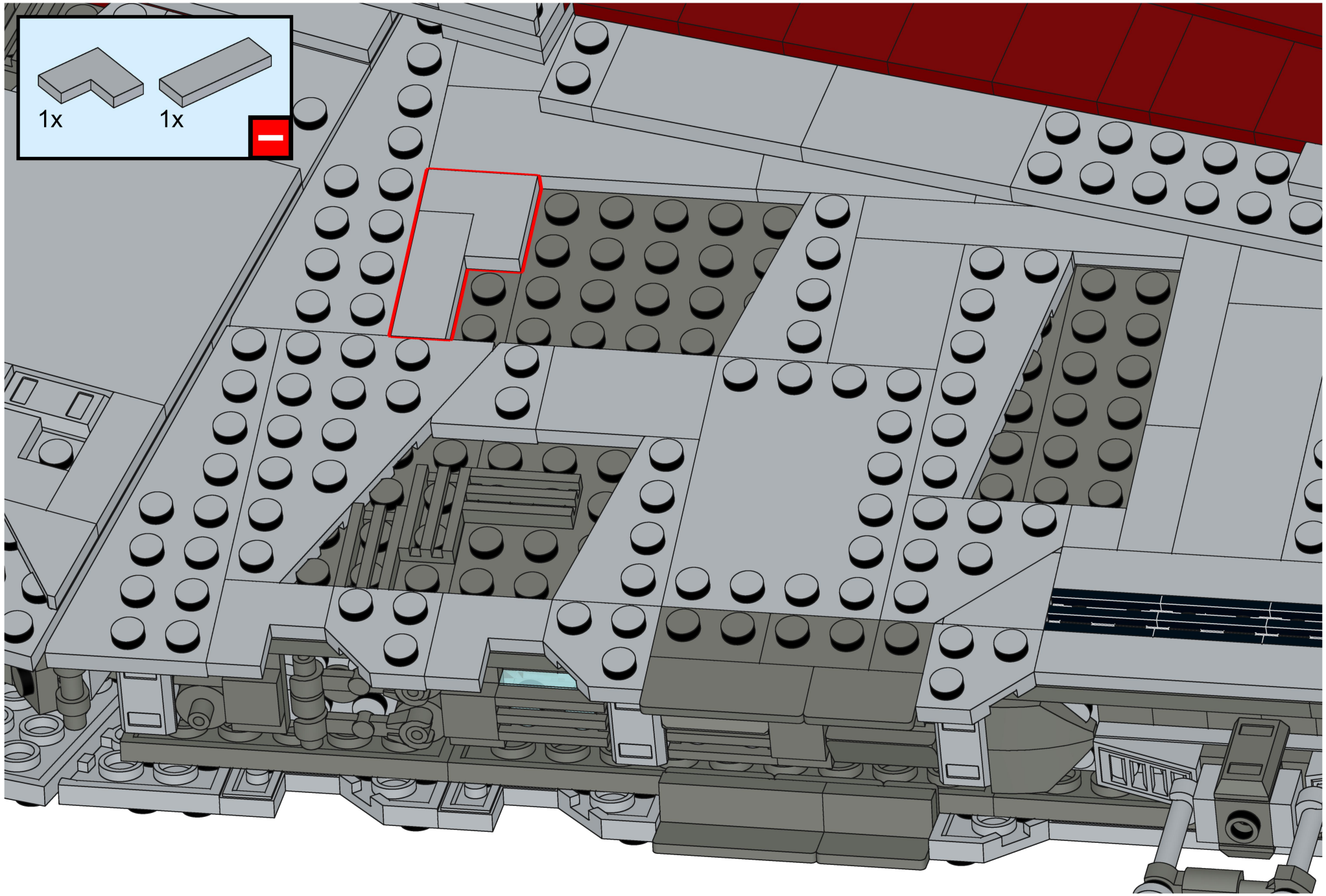





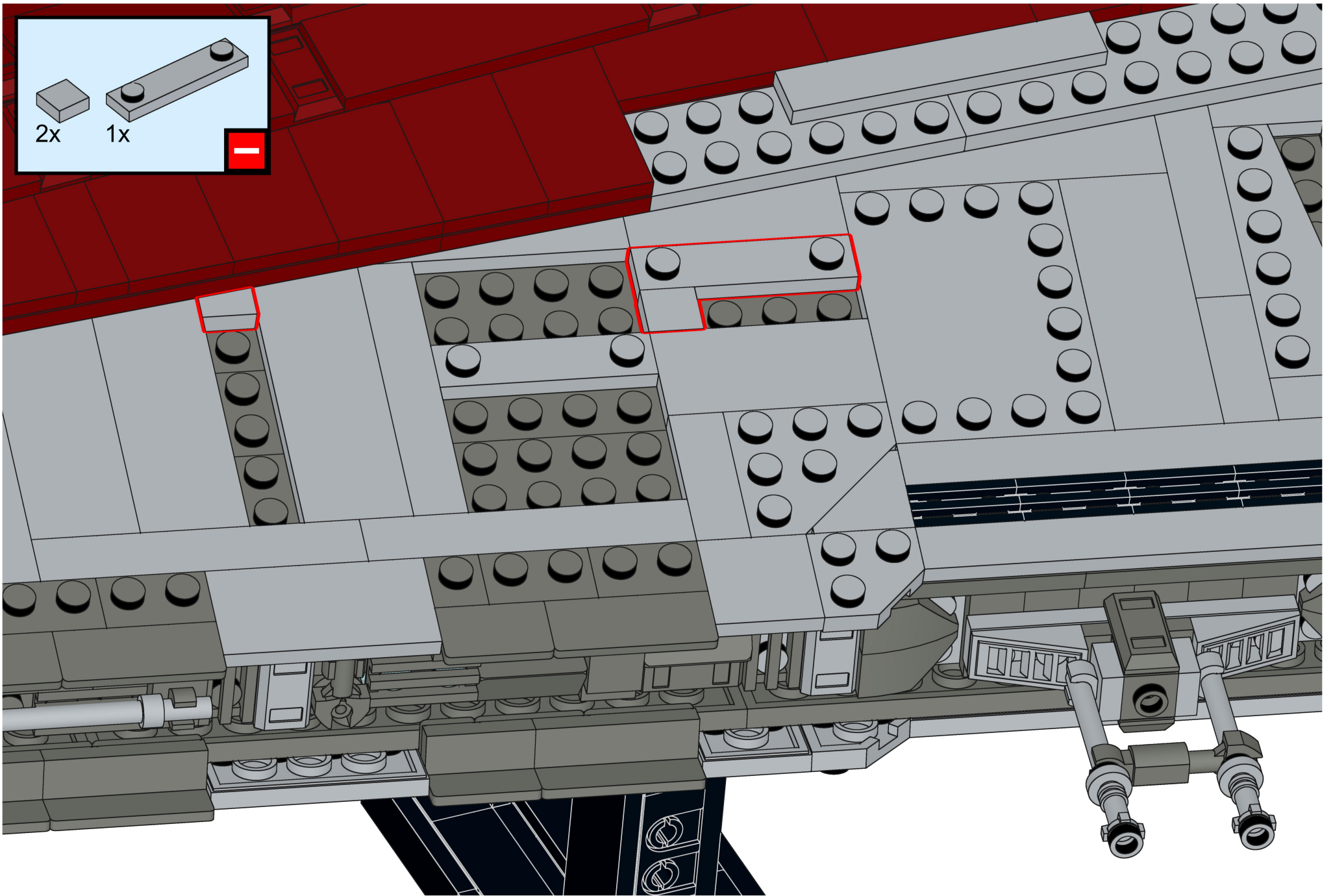
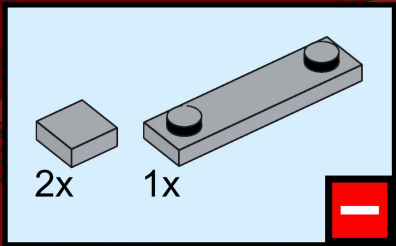

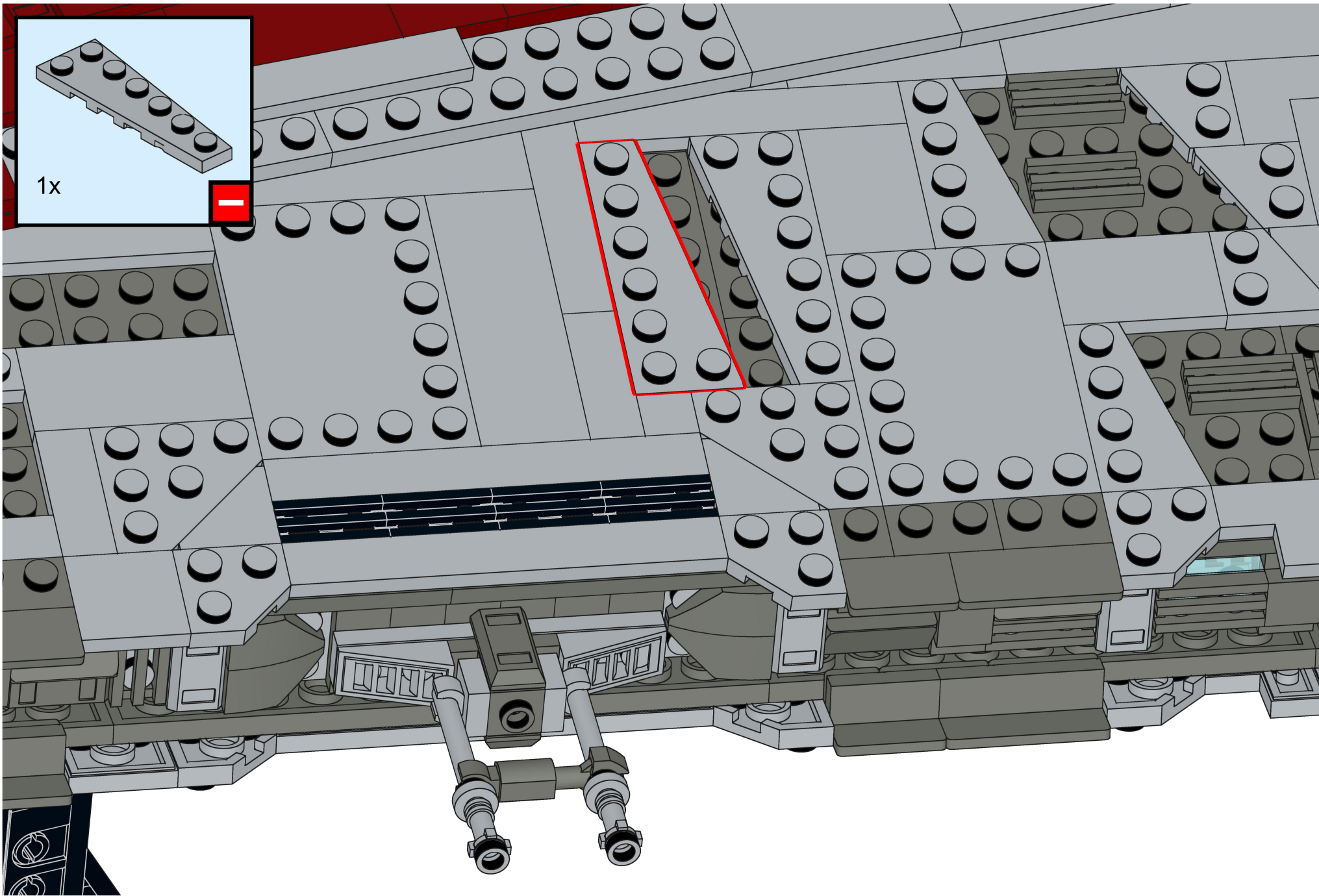

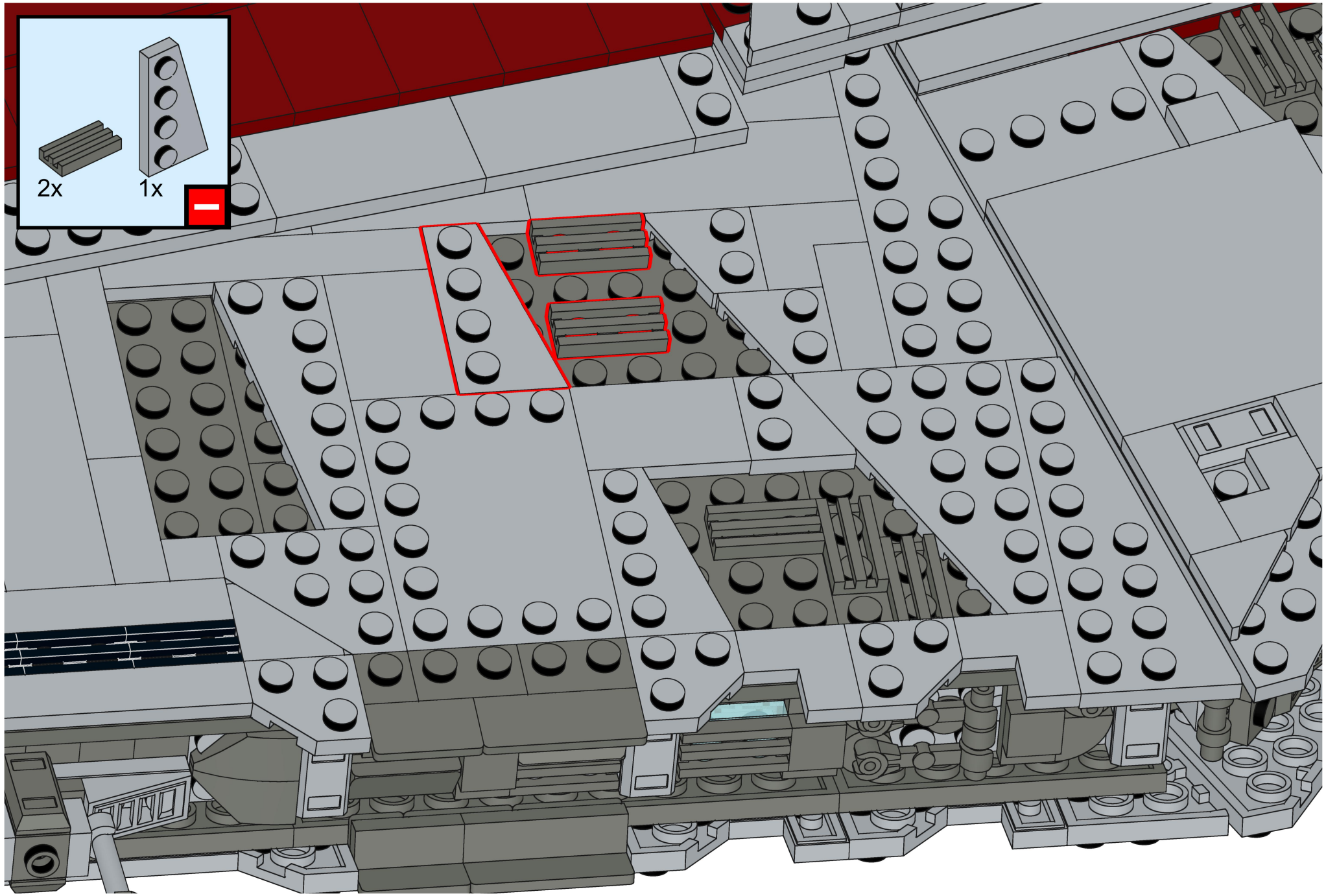
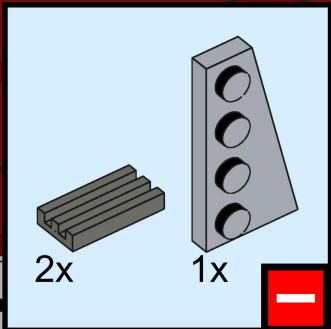

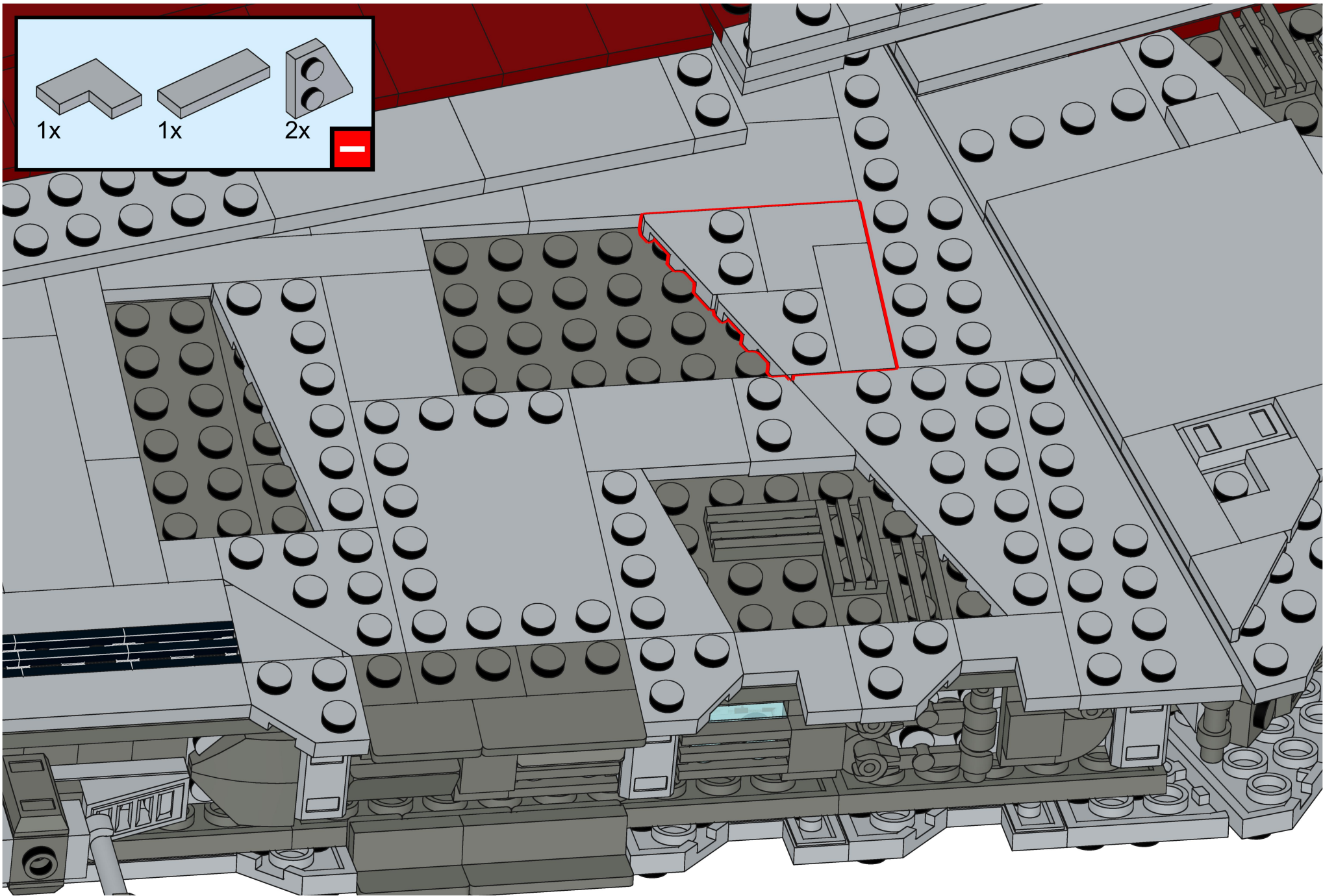

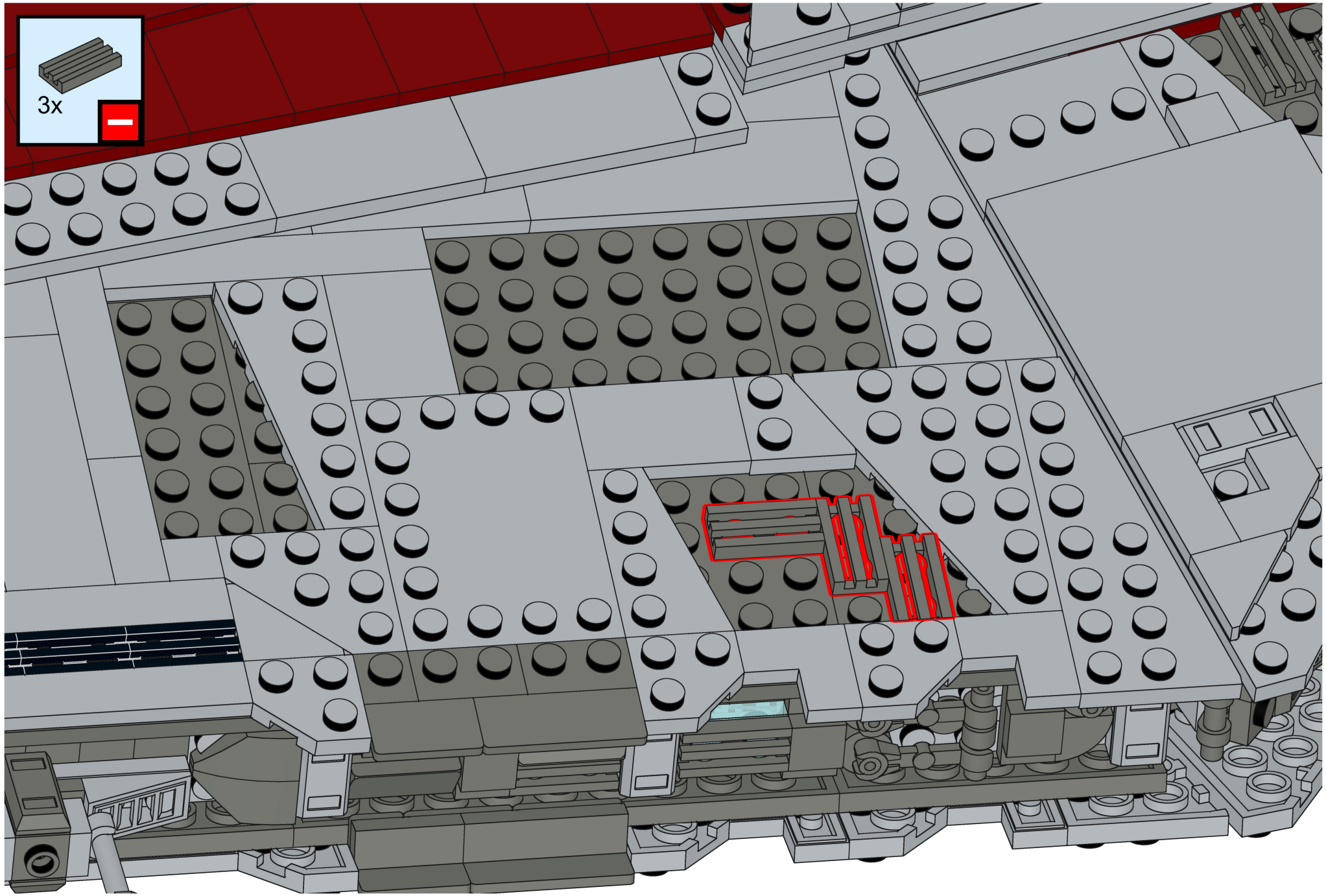
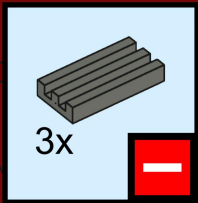

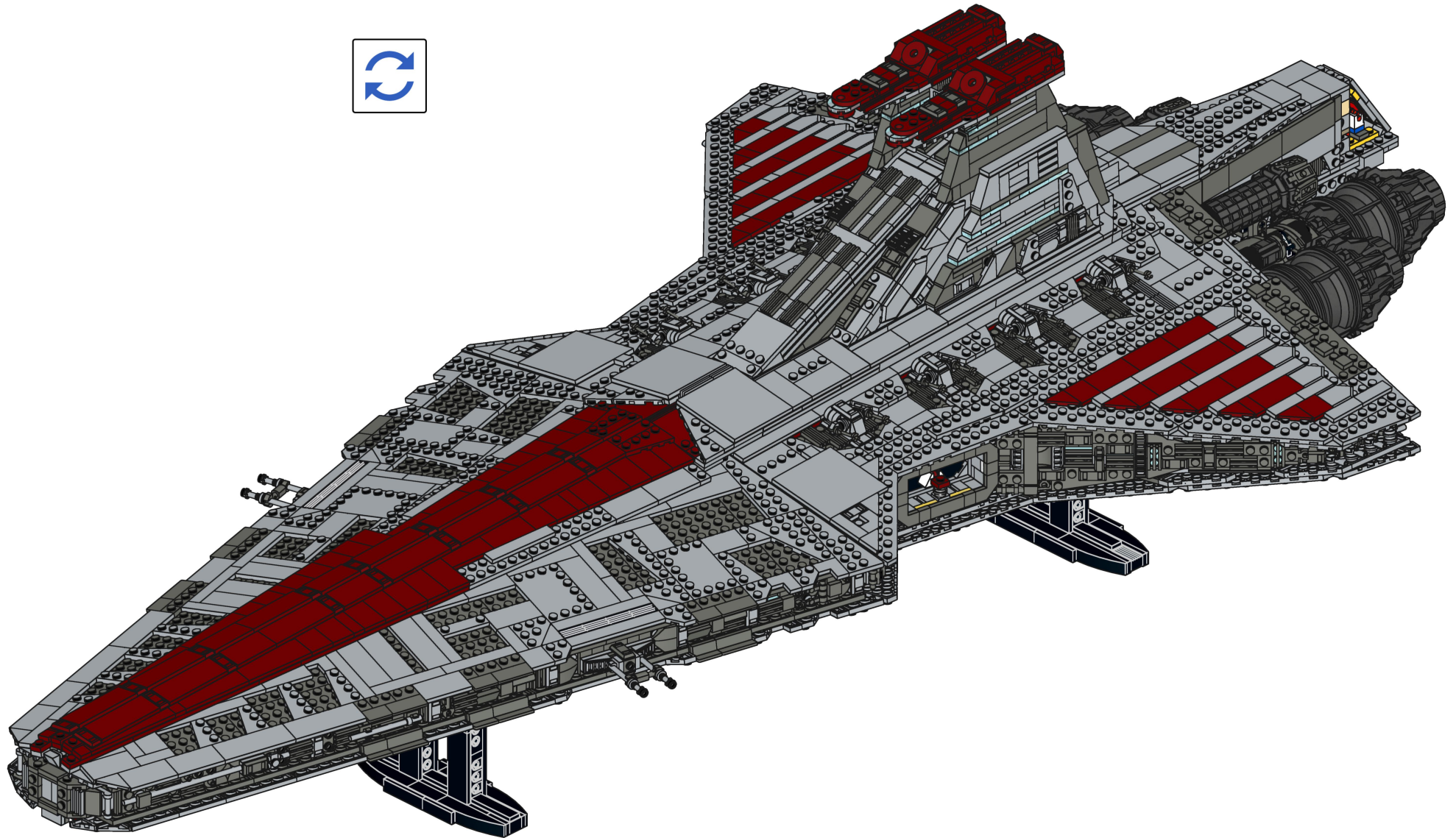



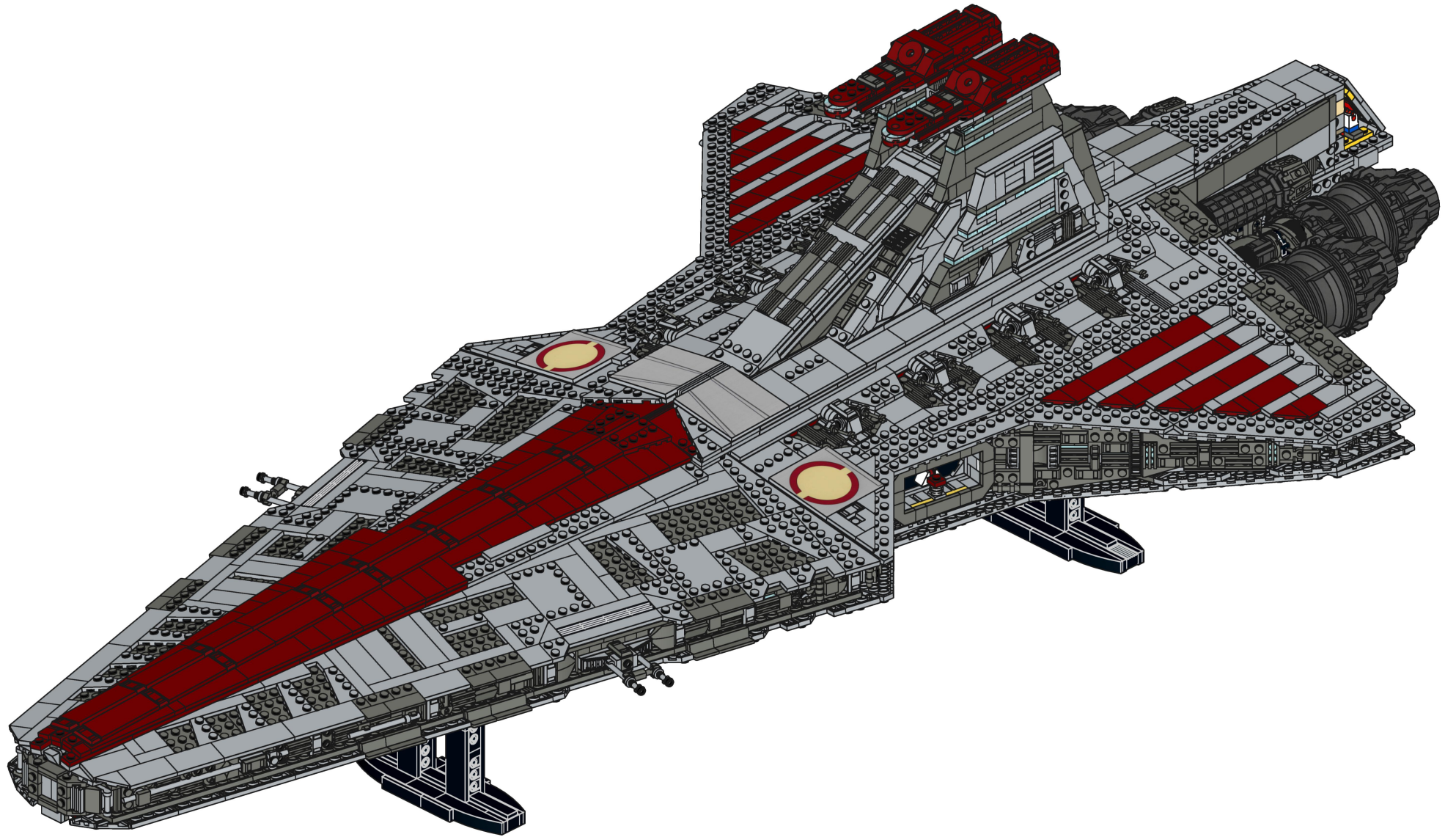

2

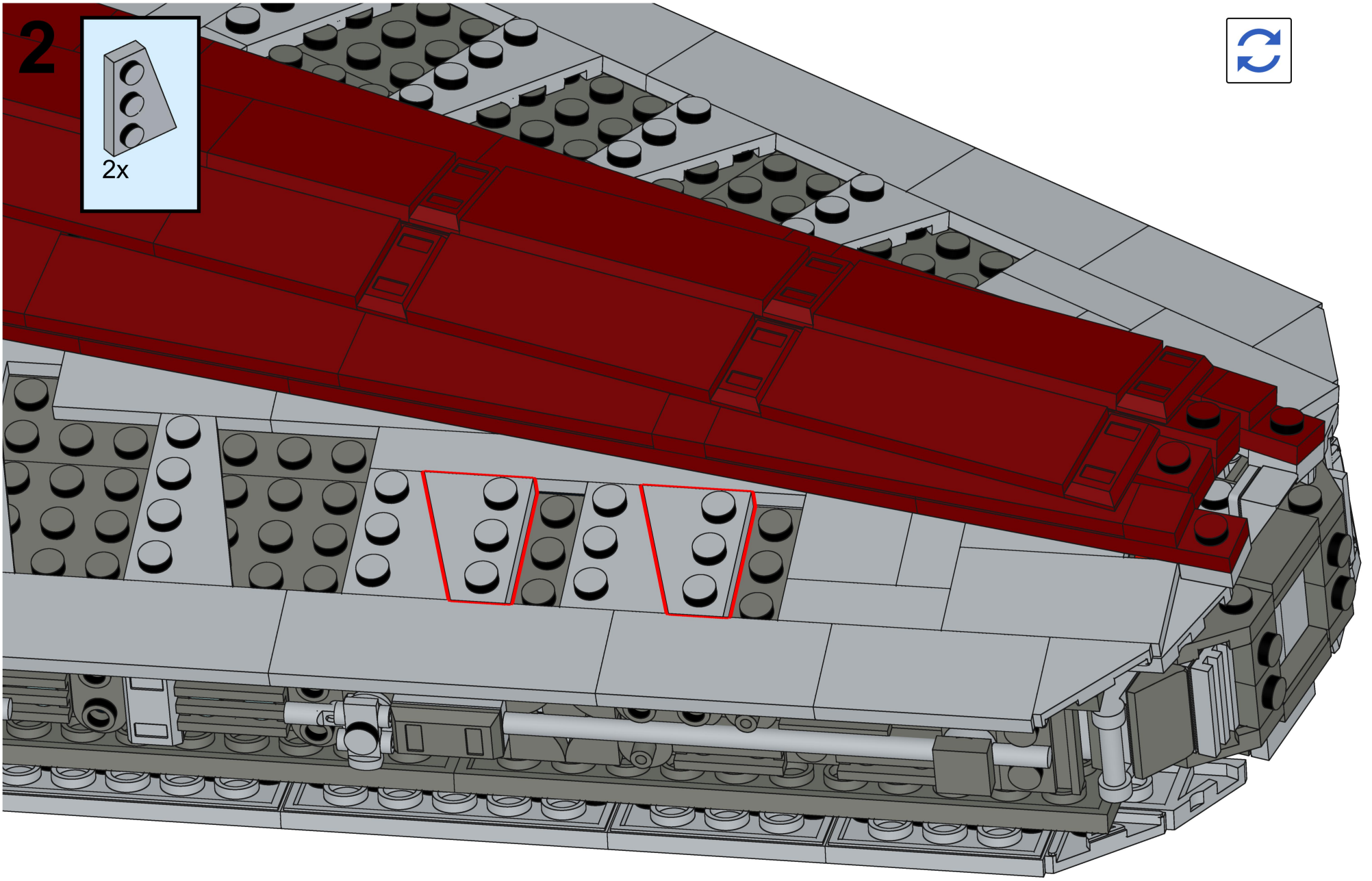
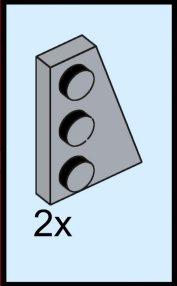

3

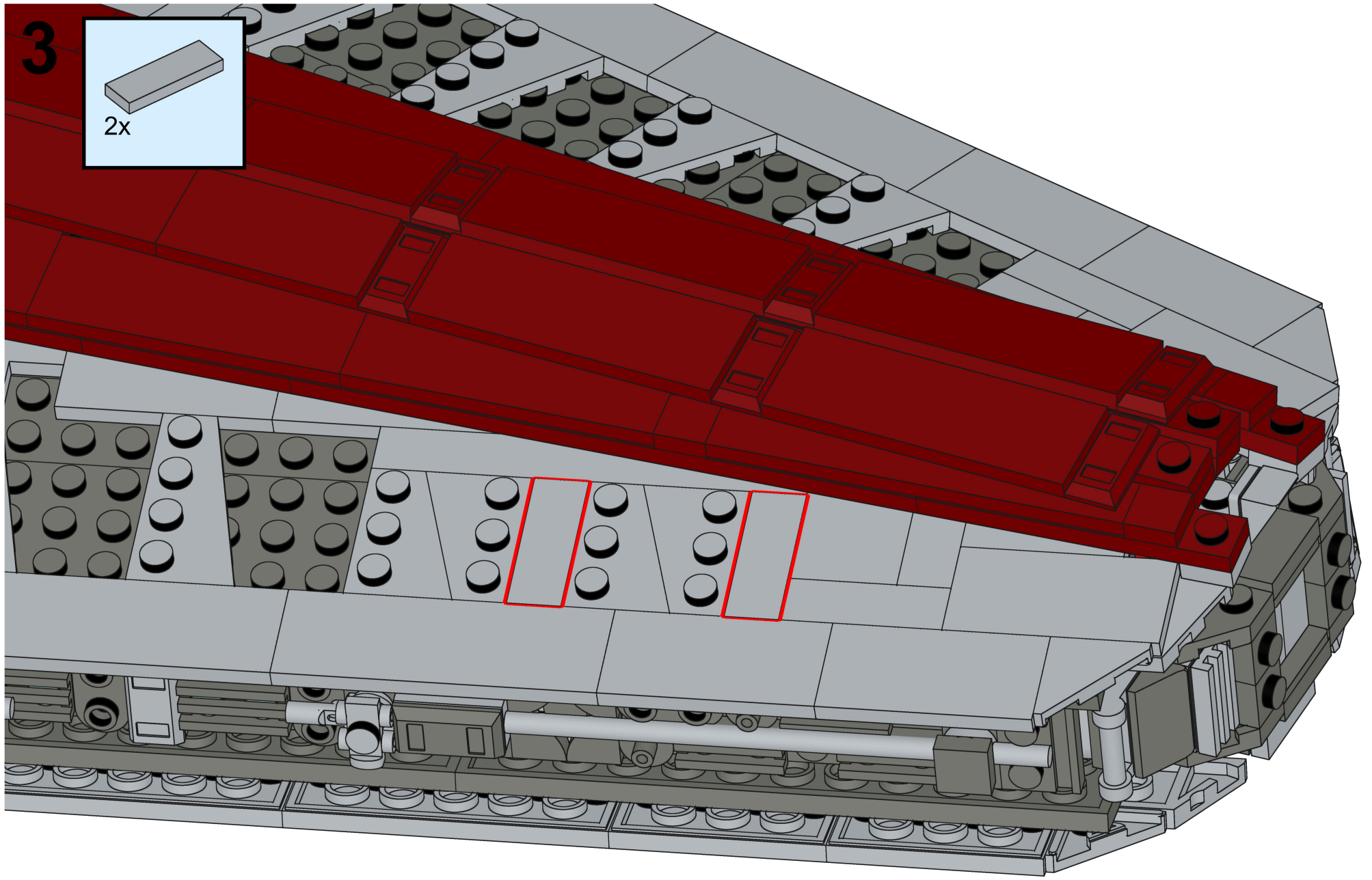
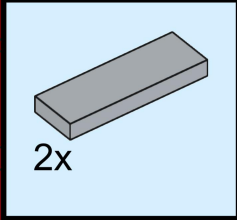

4

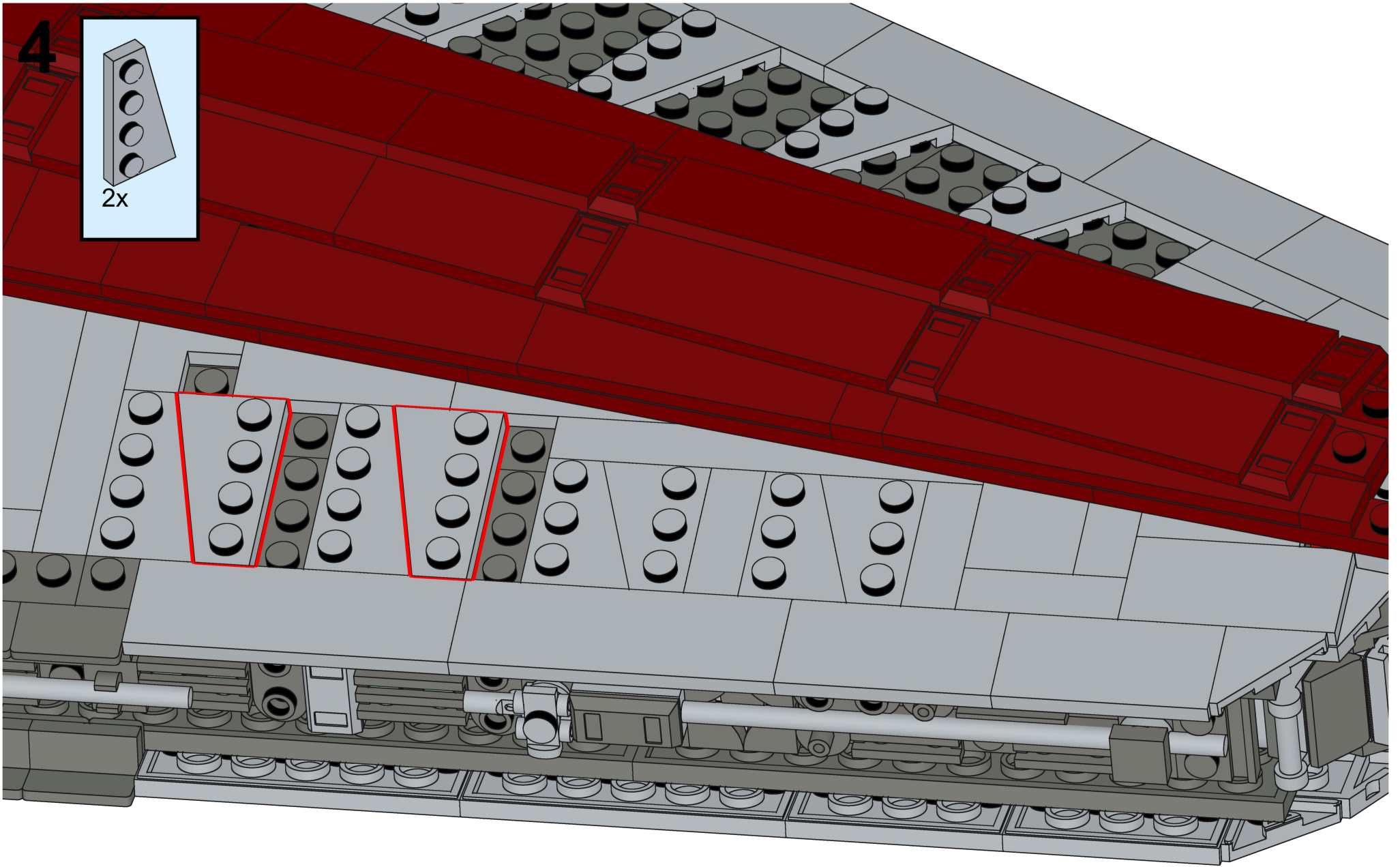
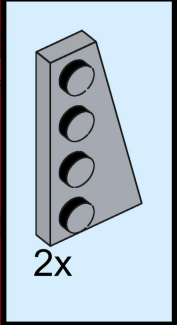

5

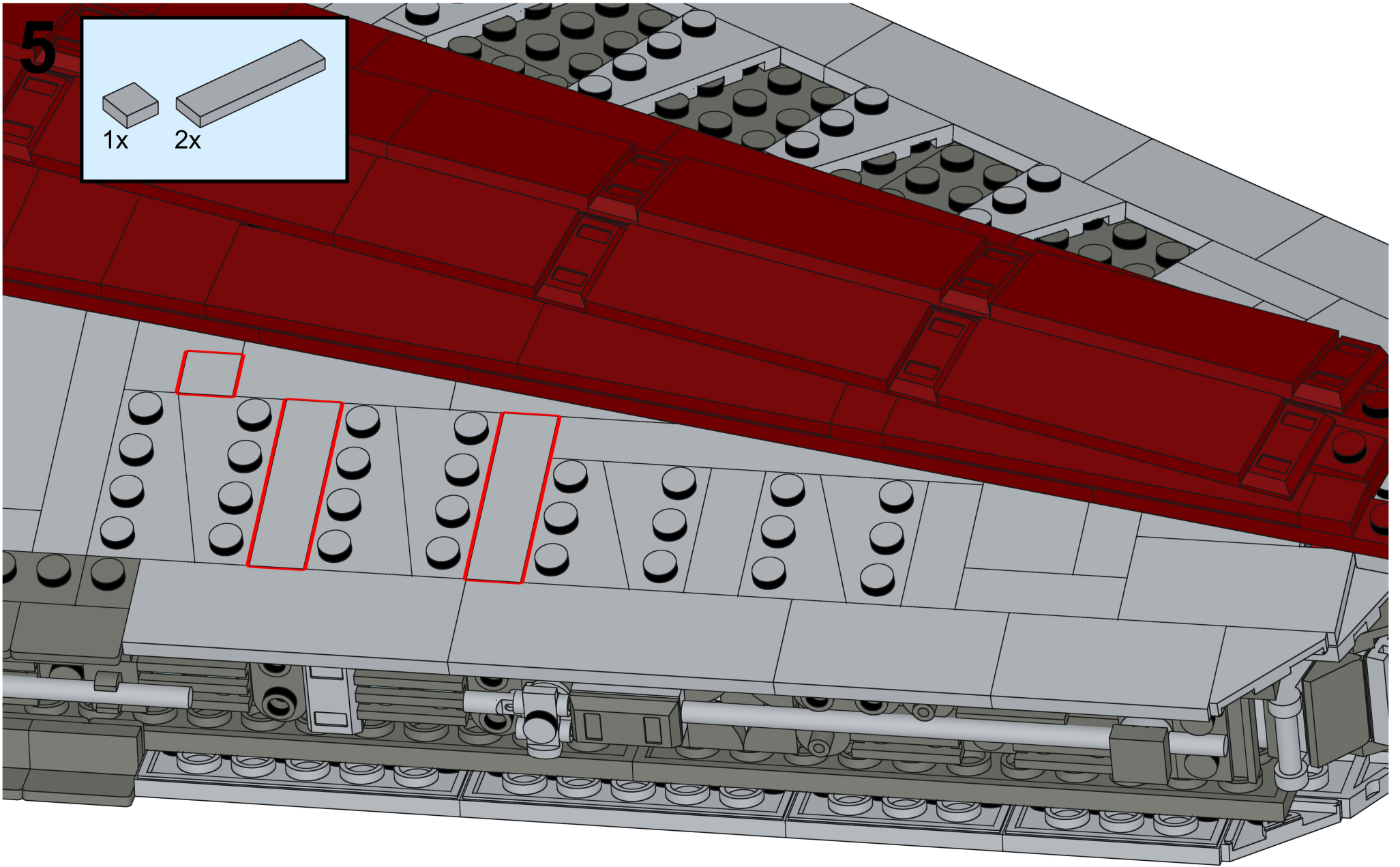
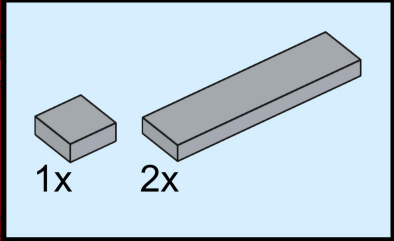

6

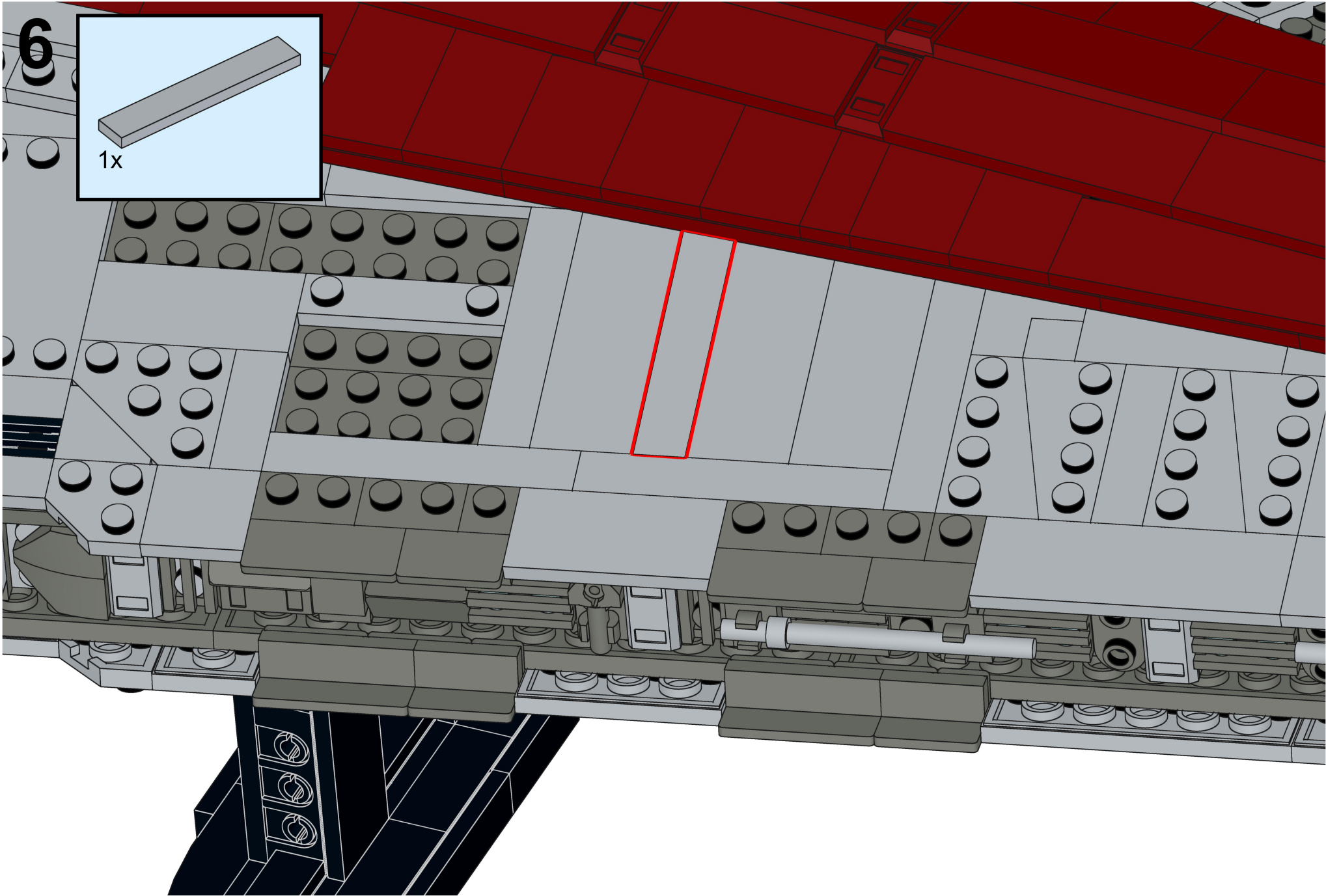
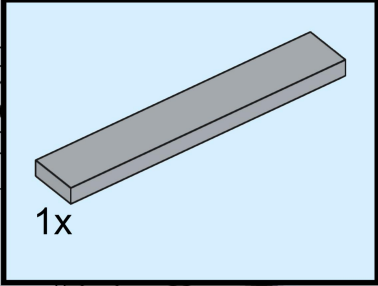

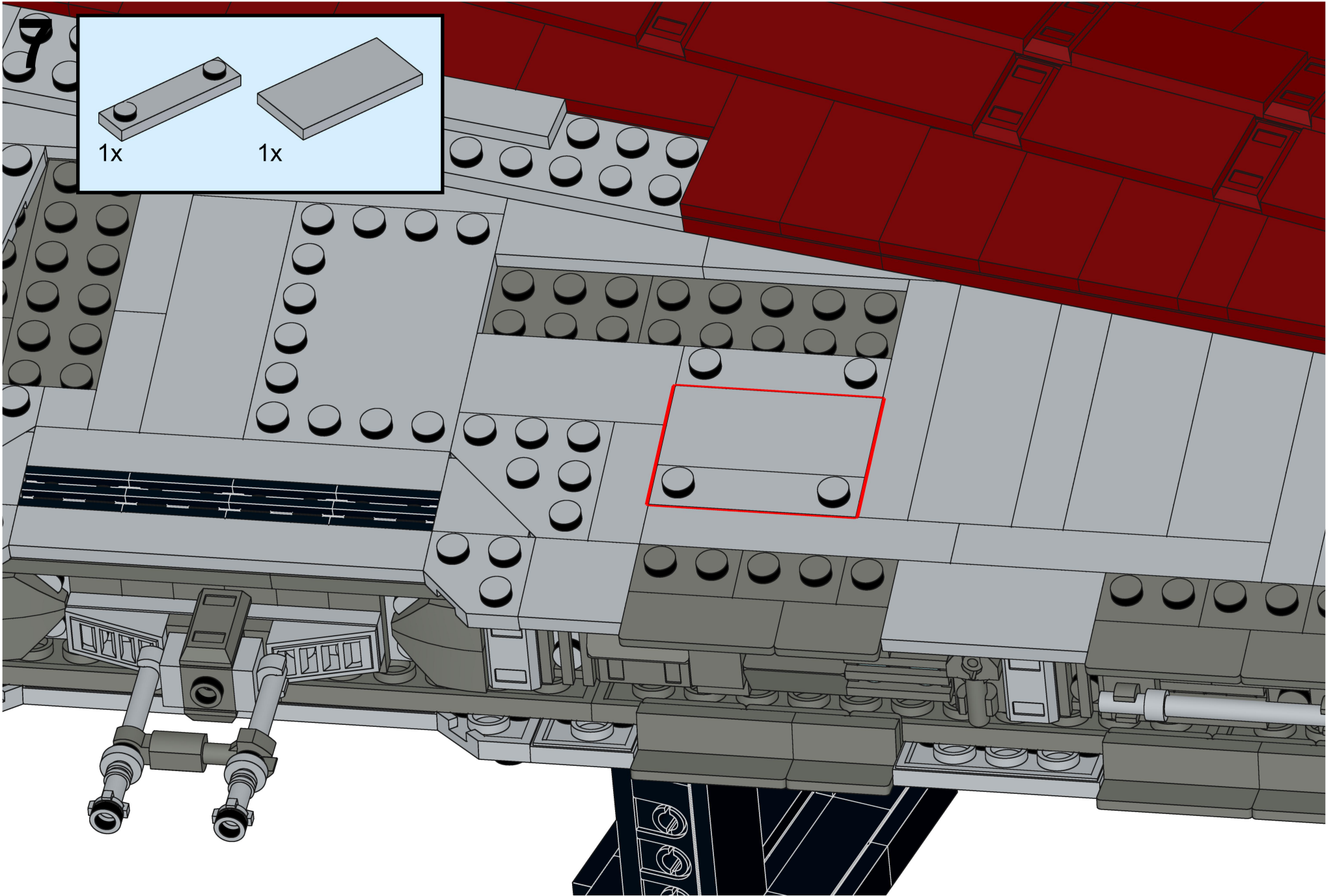

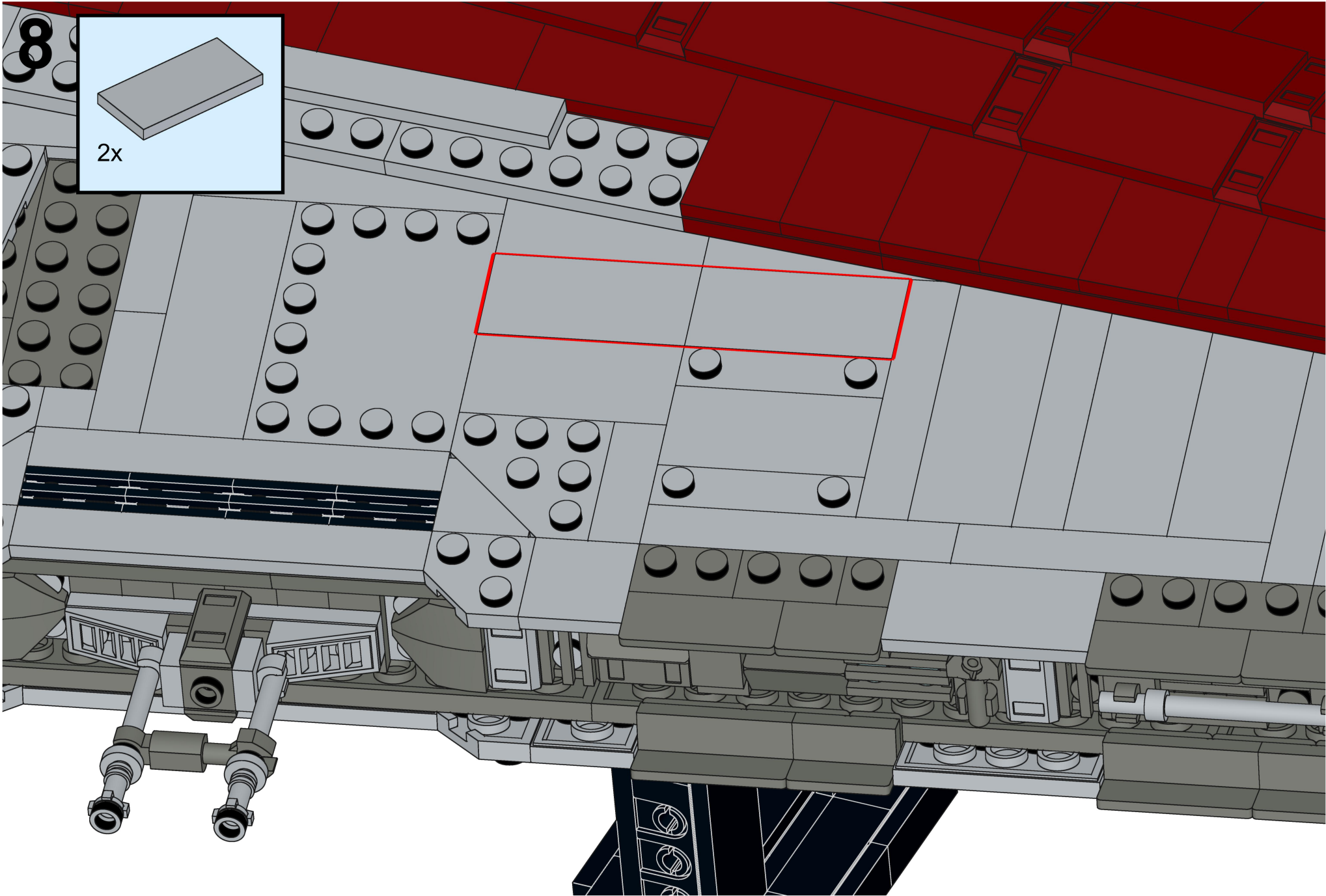

9

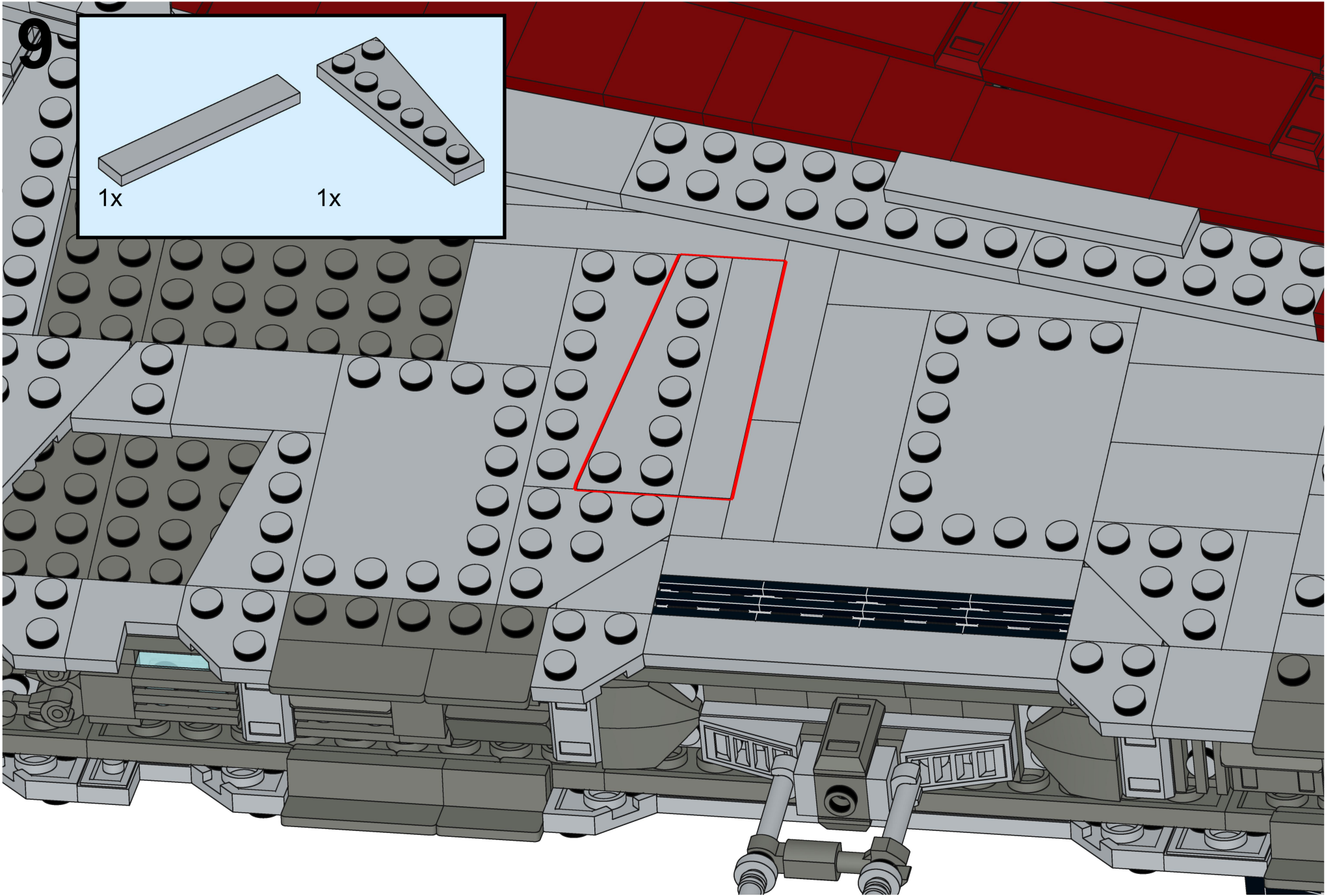
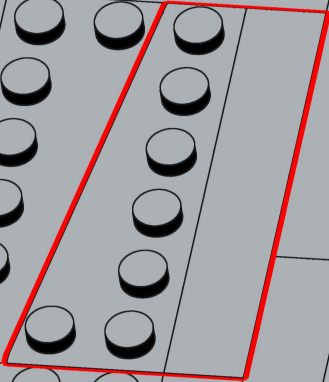
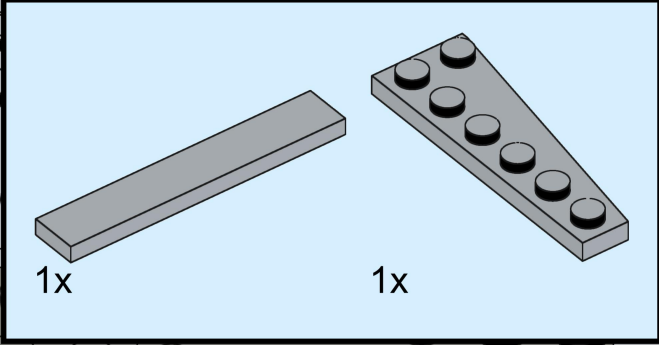

10

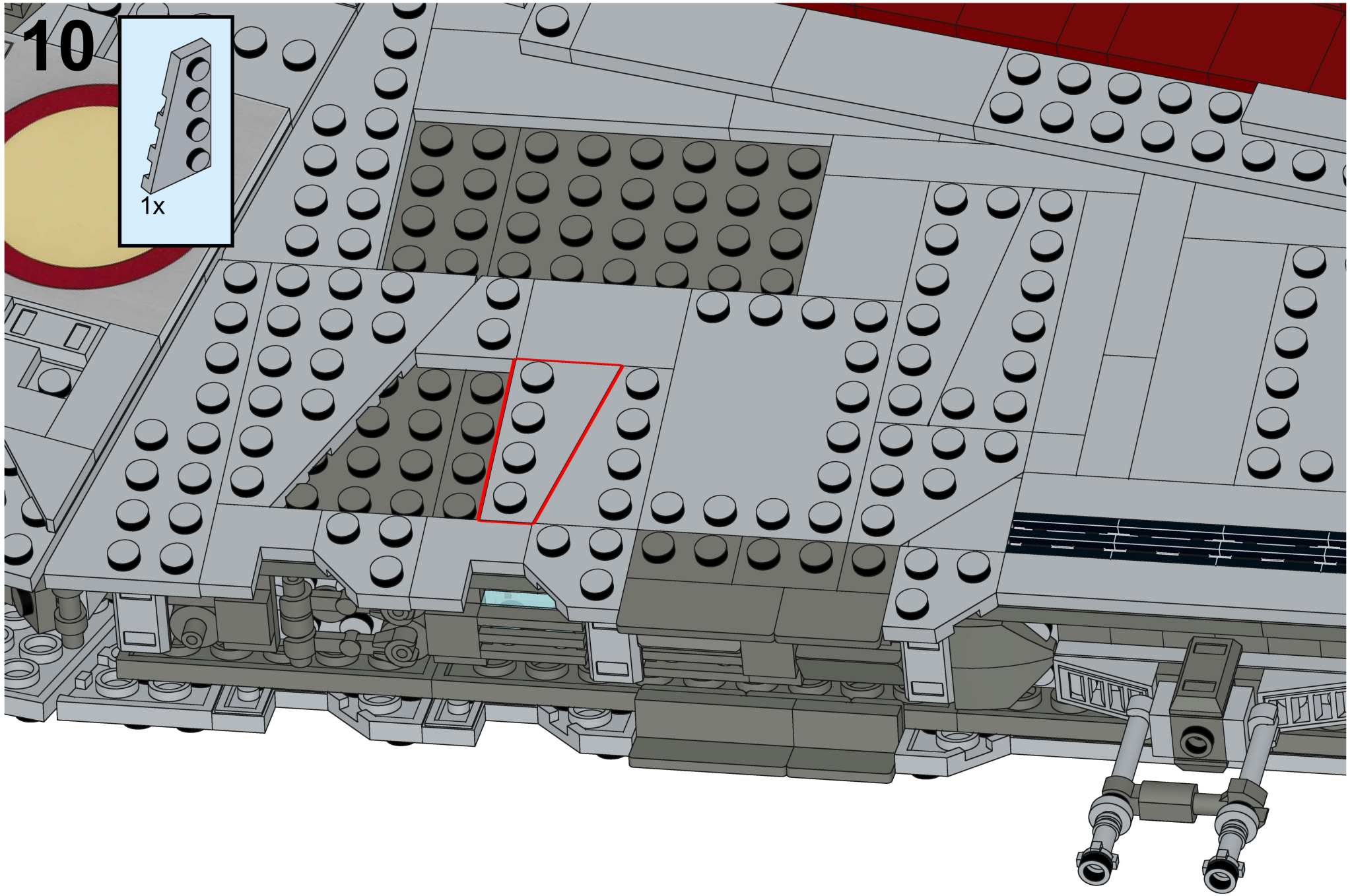
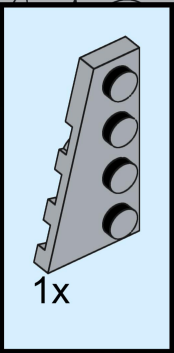

11

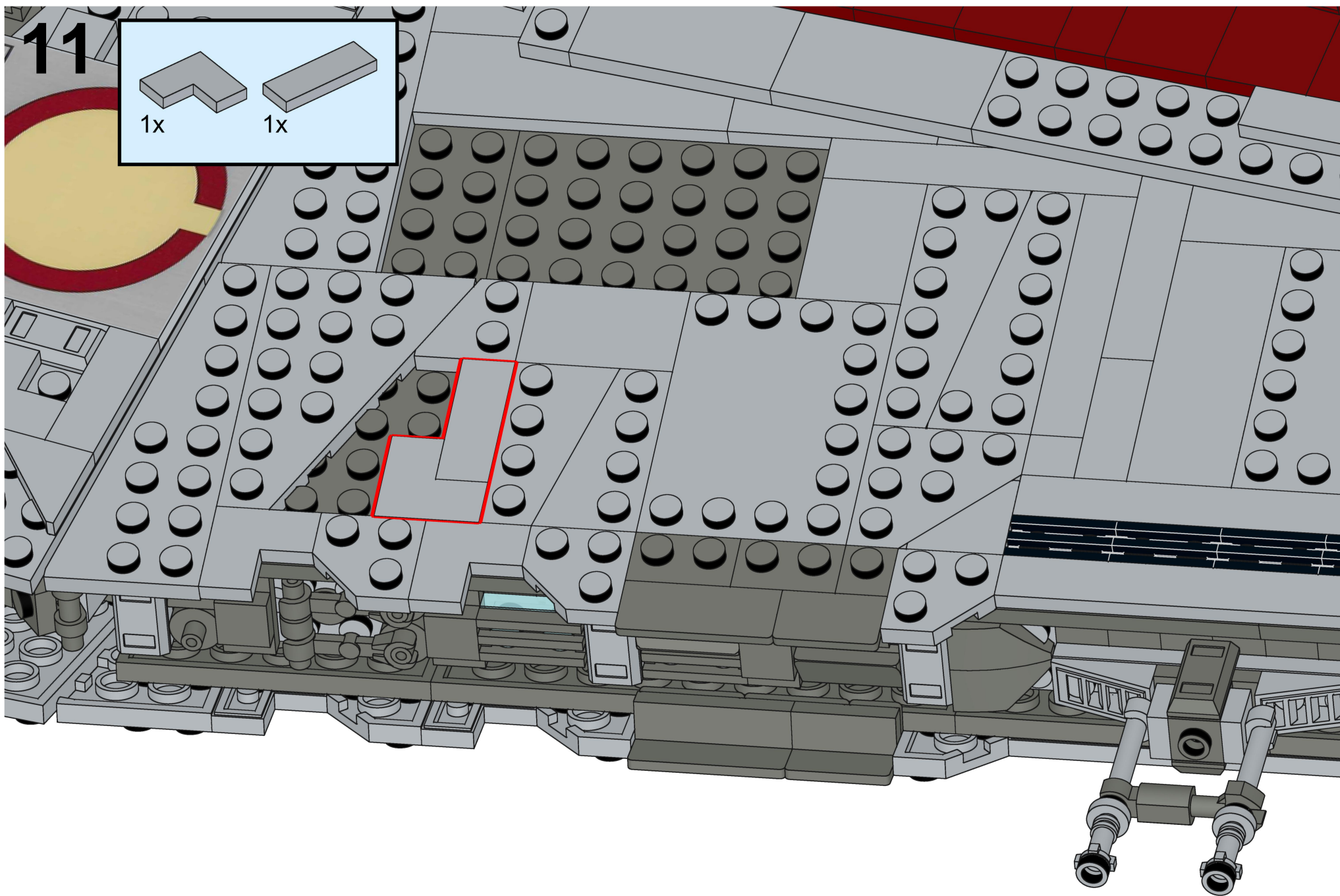
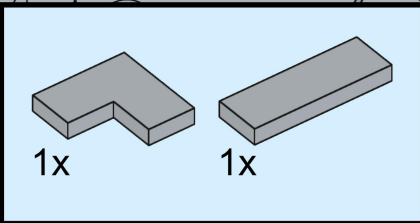

12

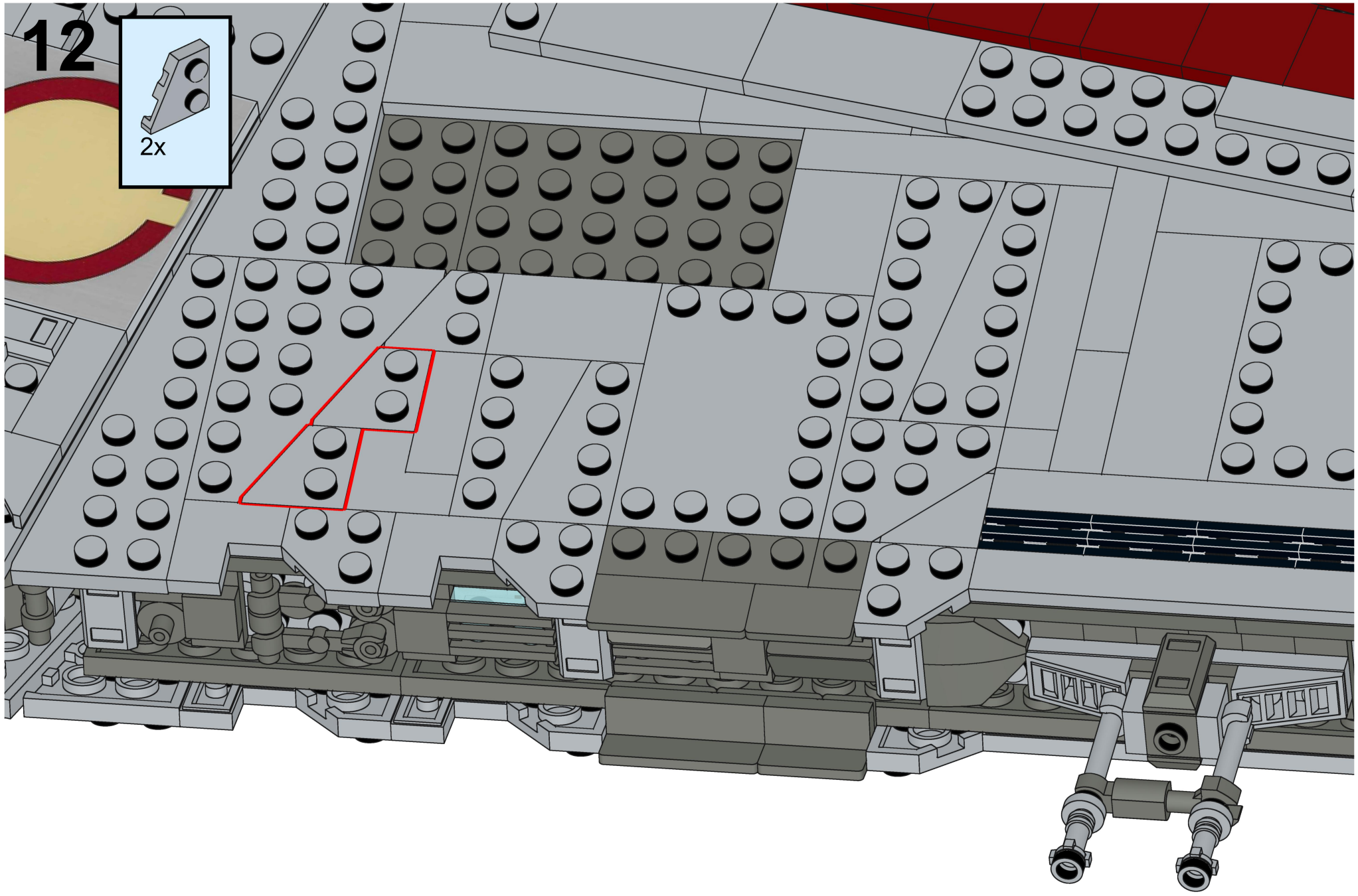
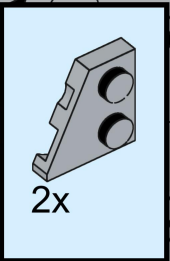

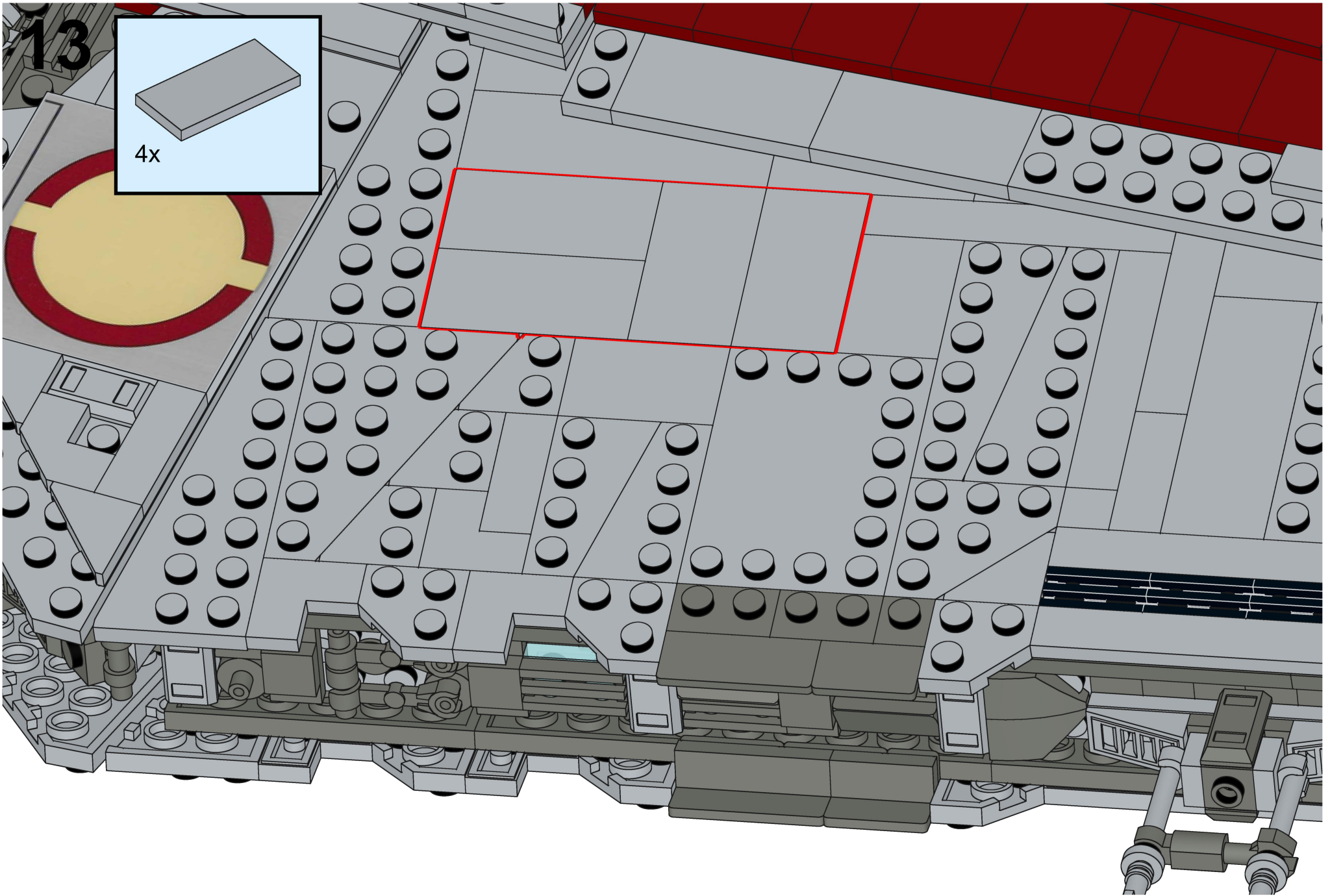

14

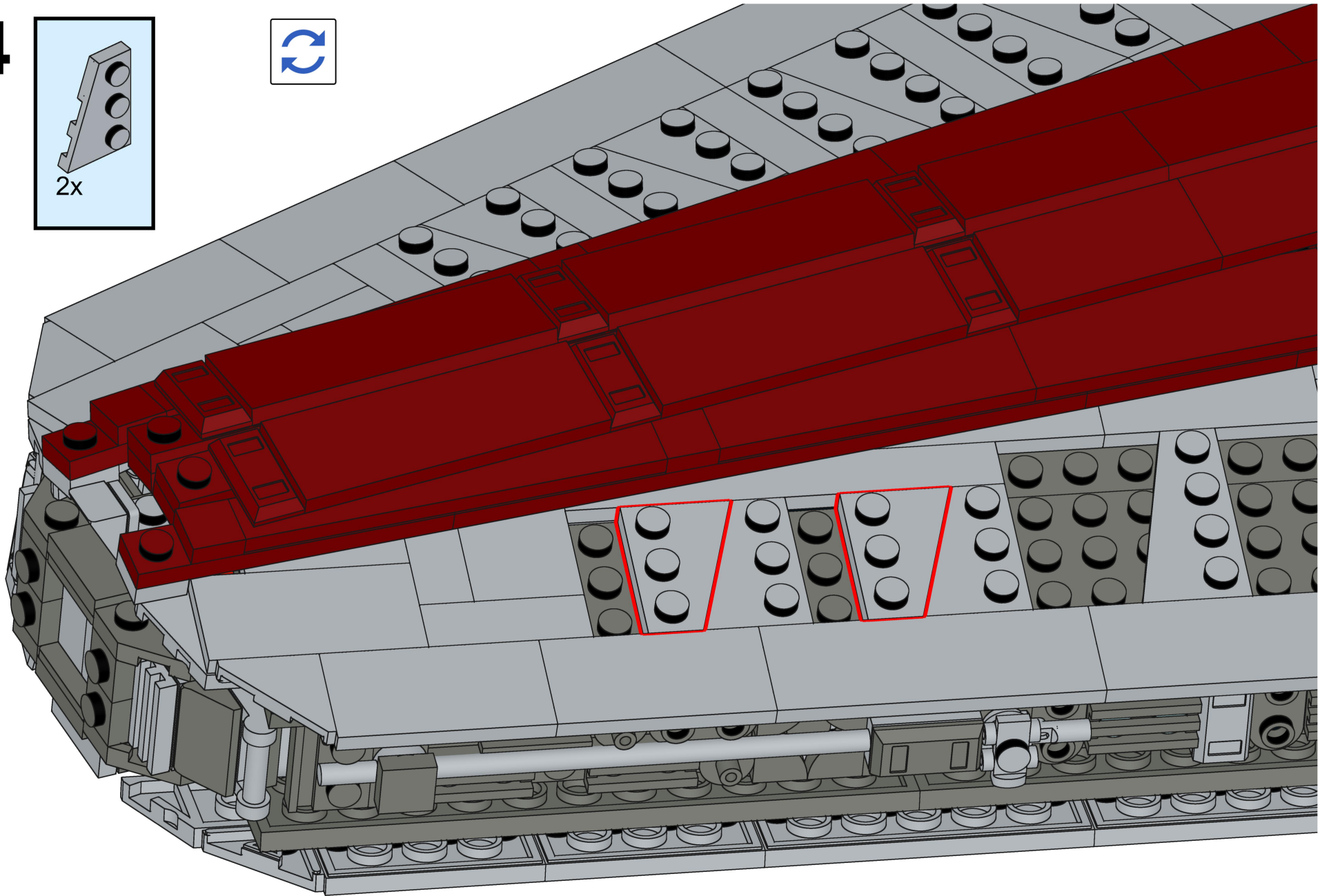
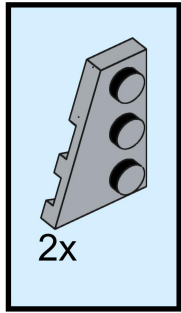

15

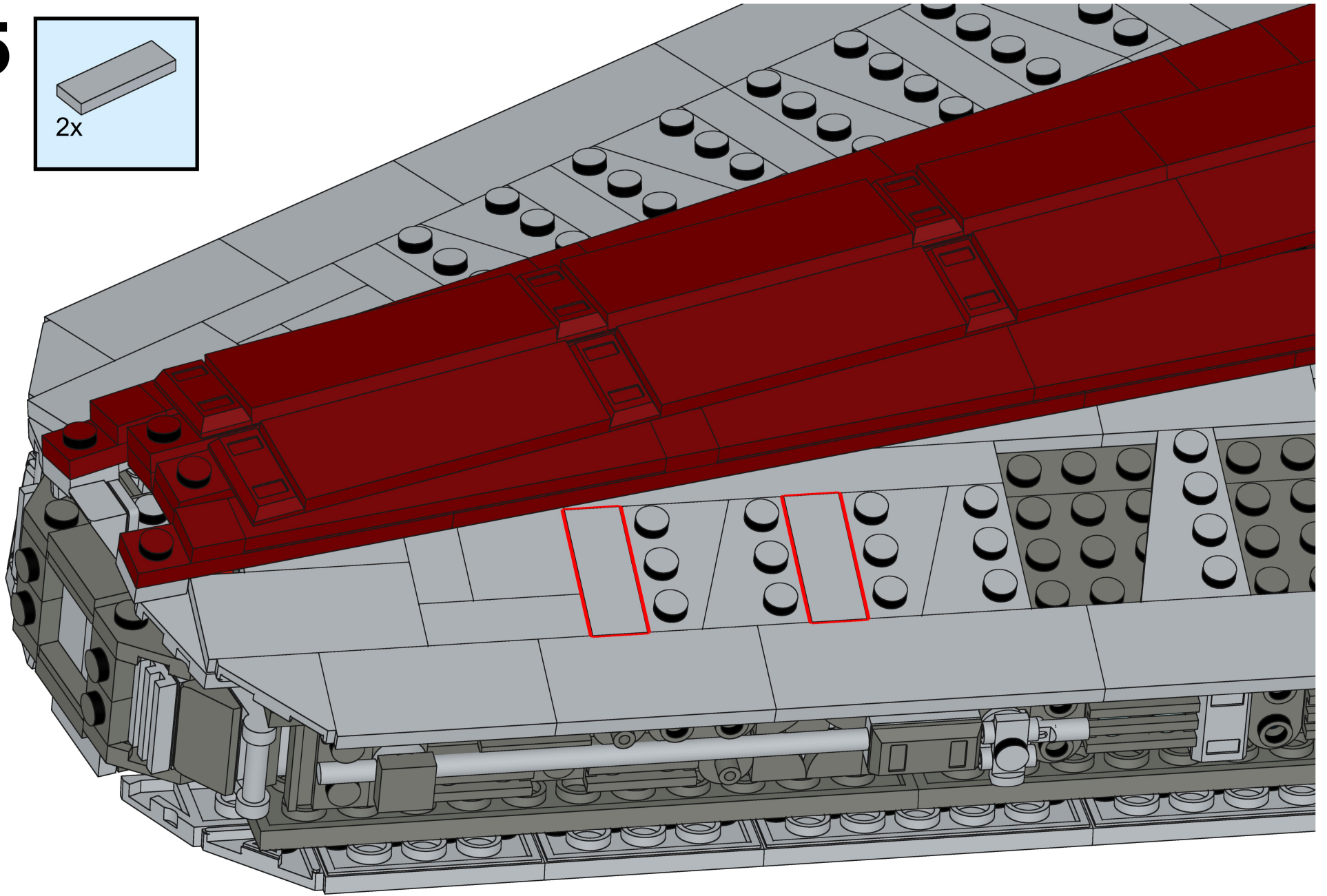
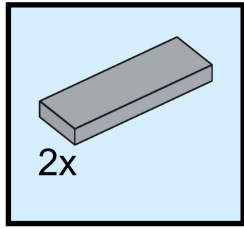

16

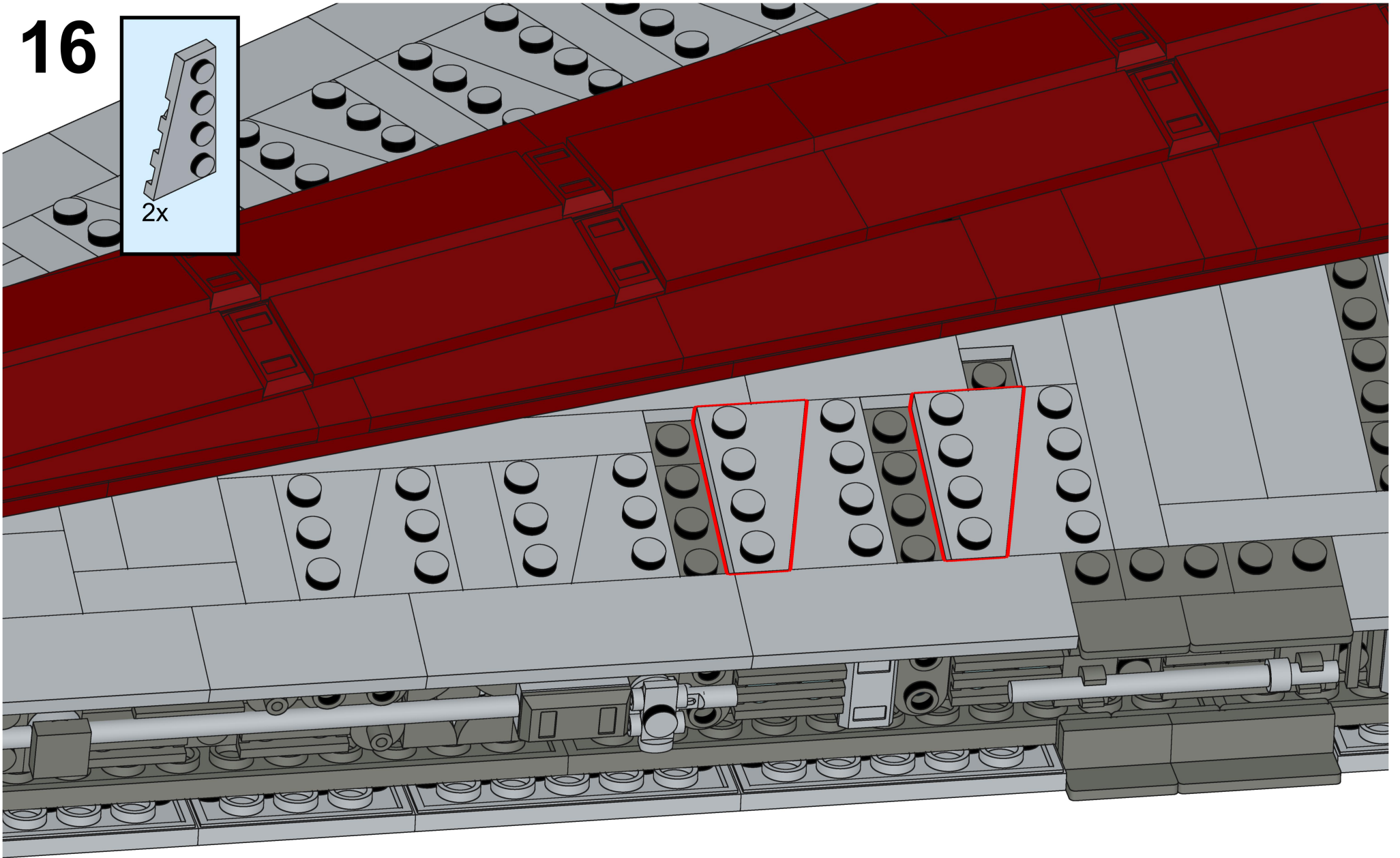
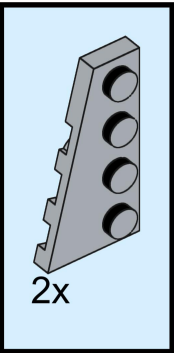

17

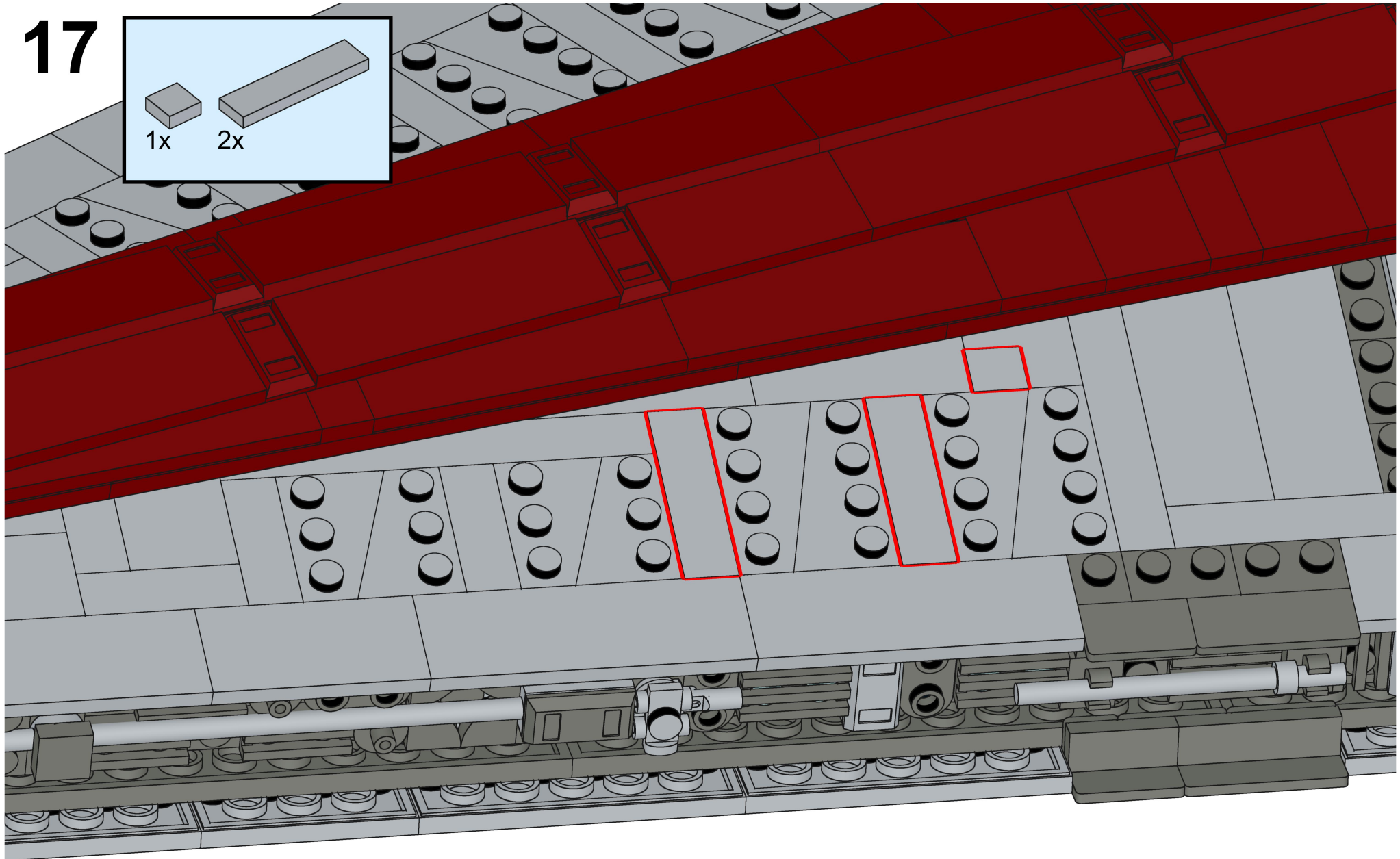
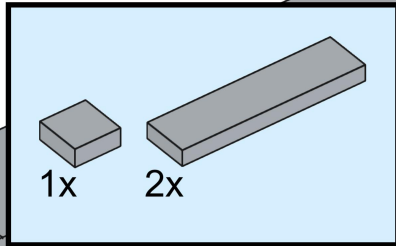

18

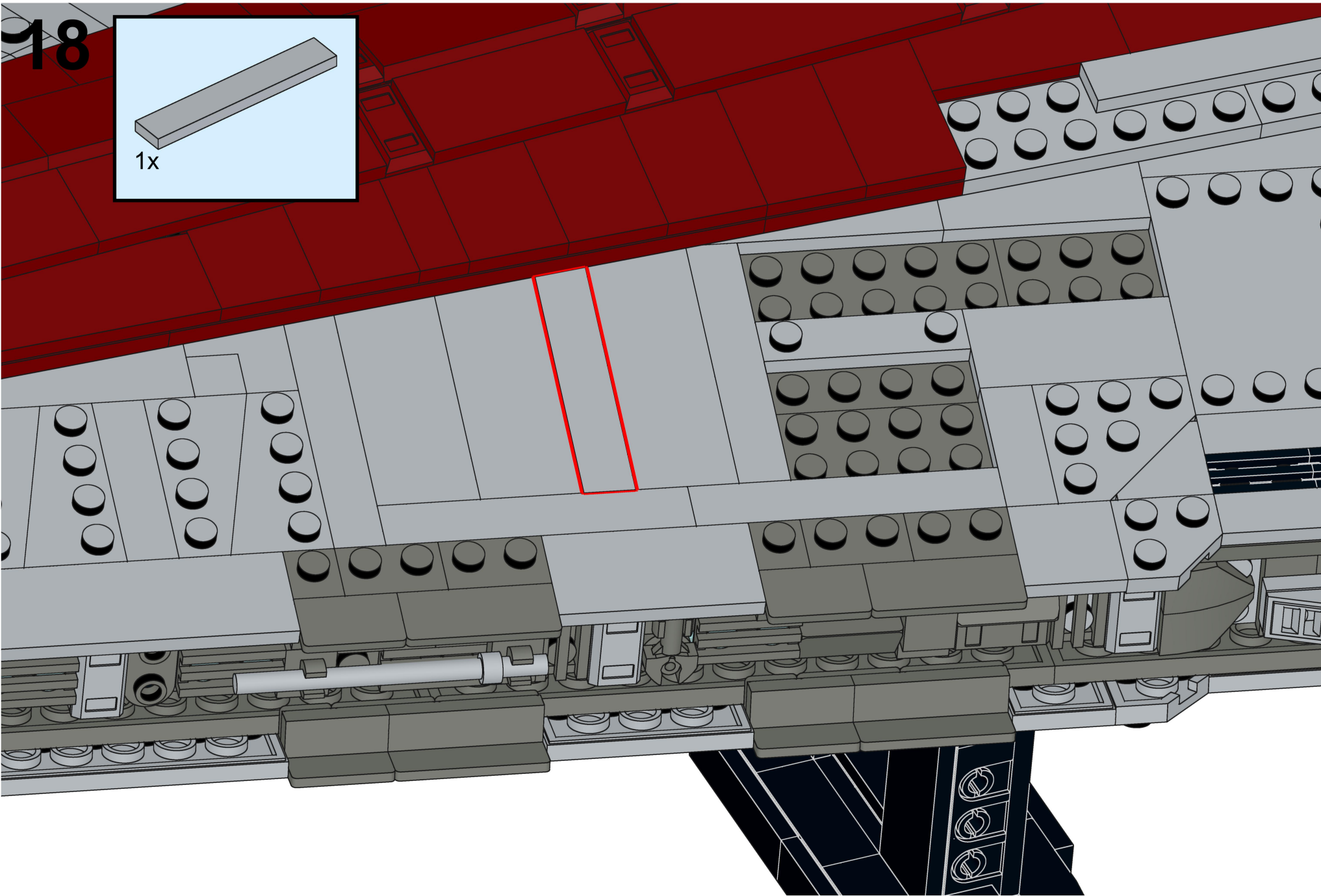
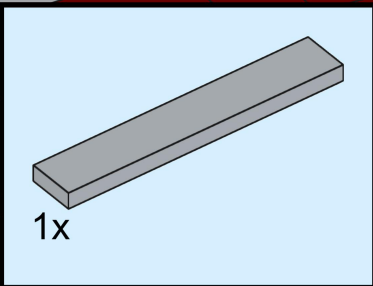

19

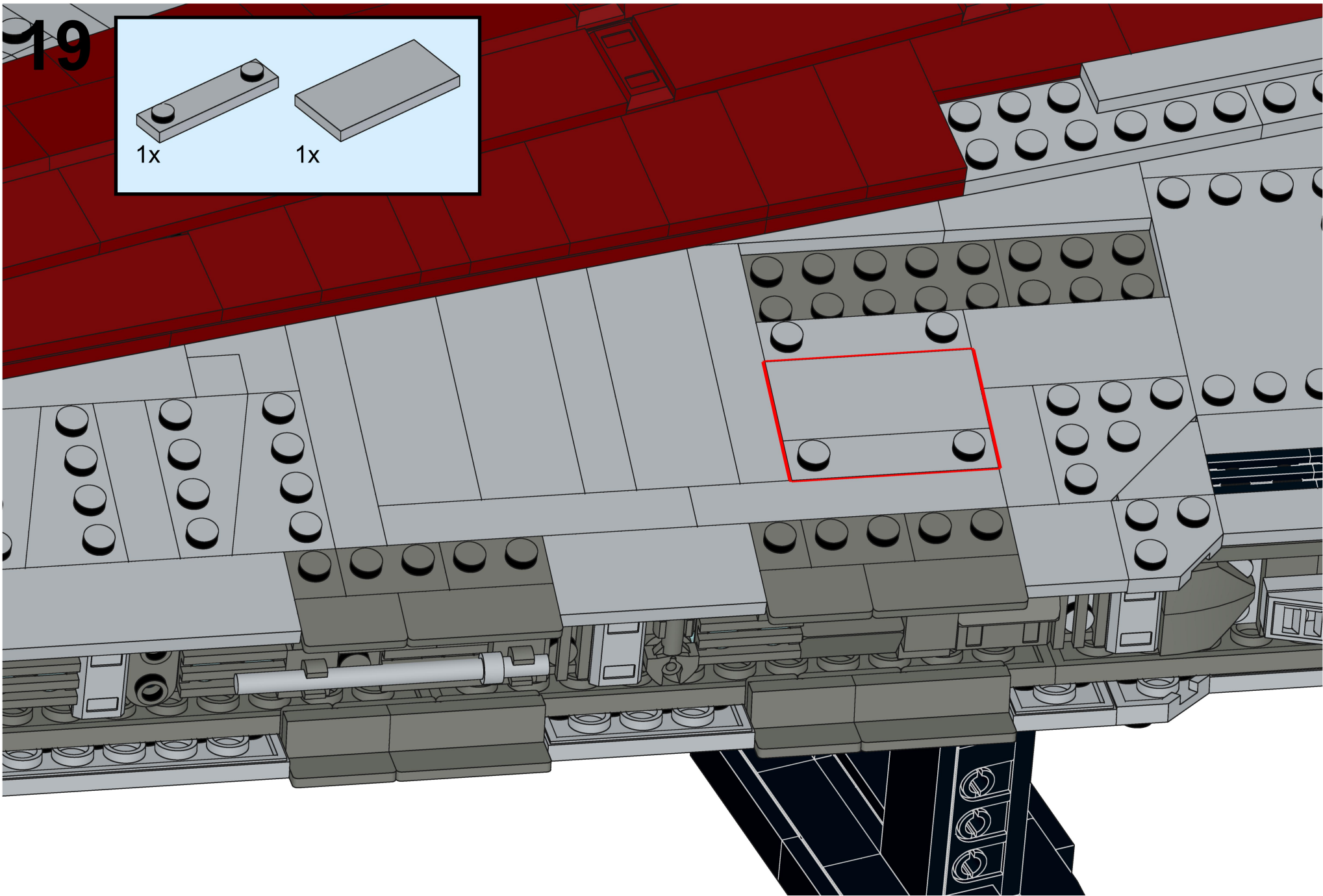
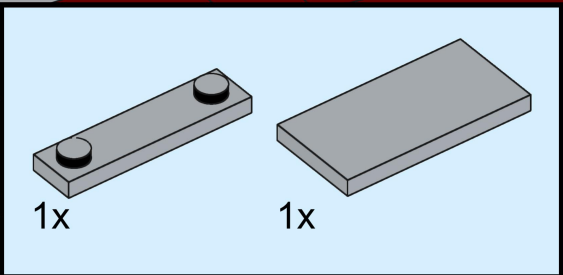

20

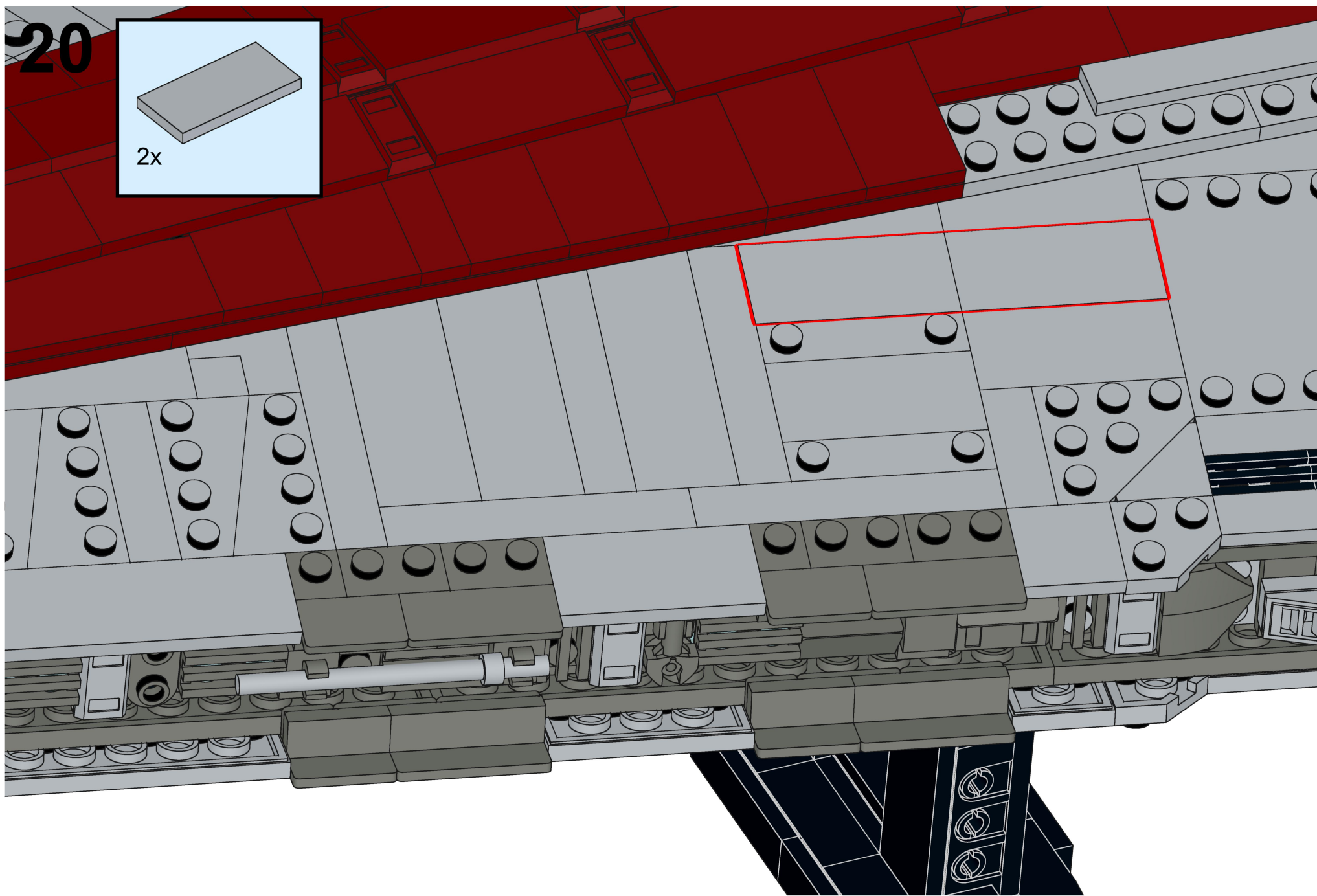
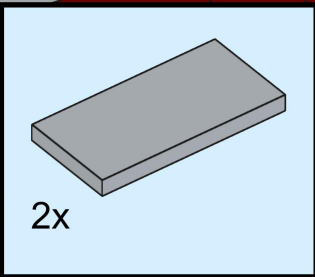

21

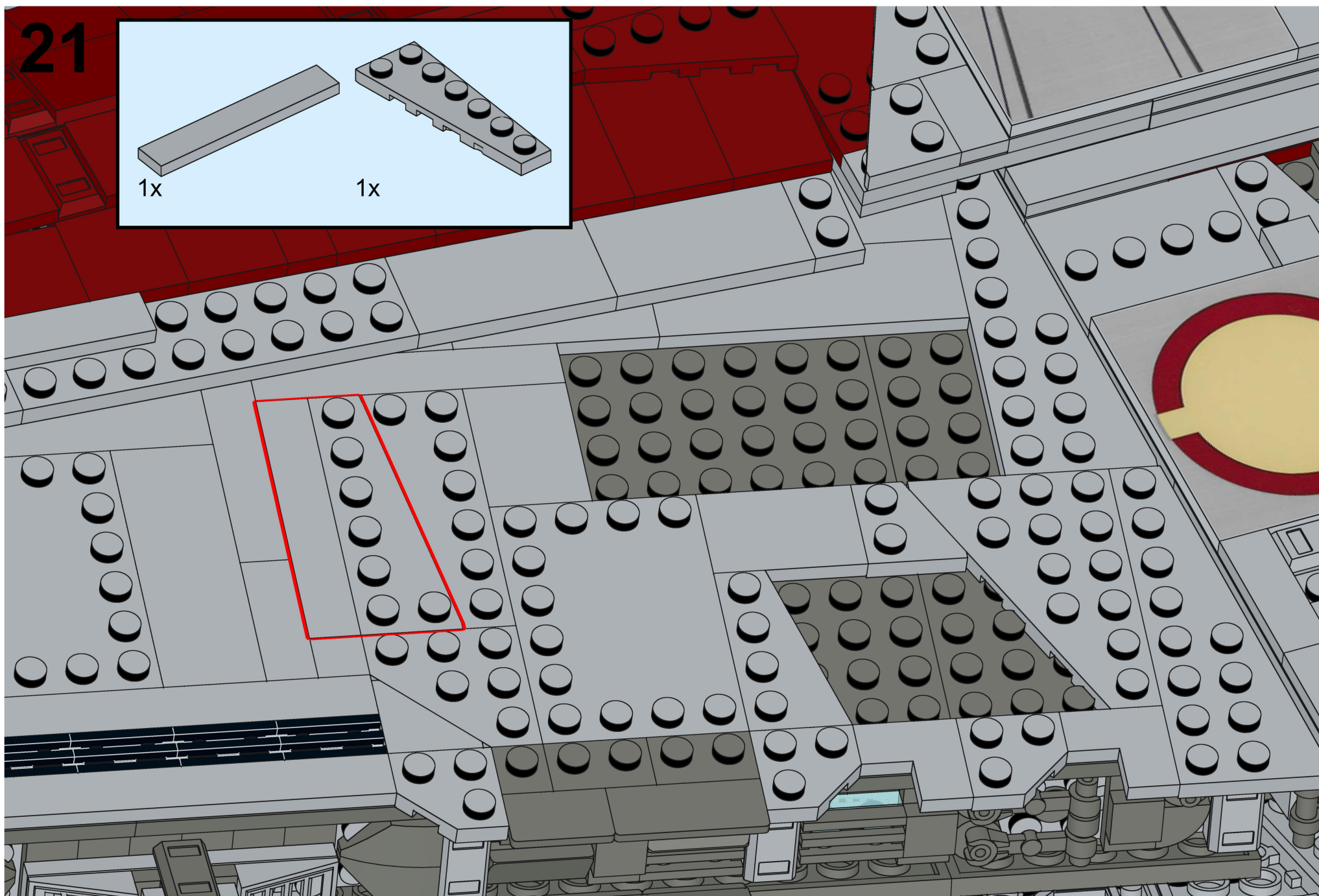
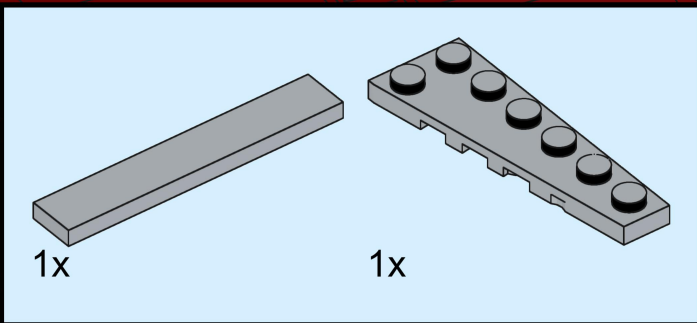

22

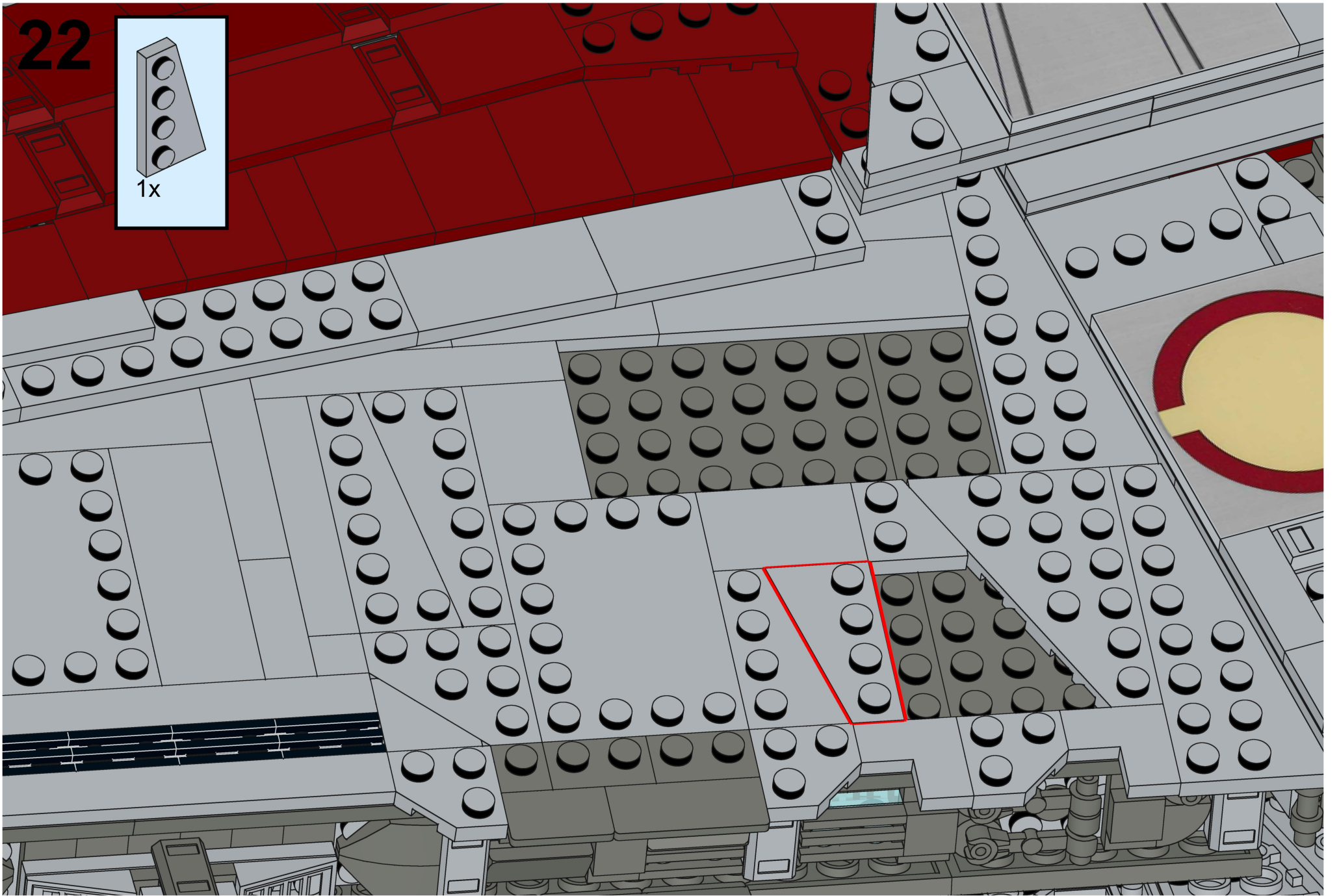
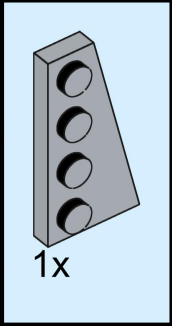

23

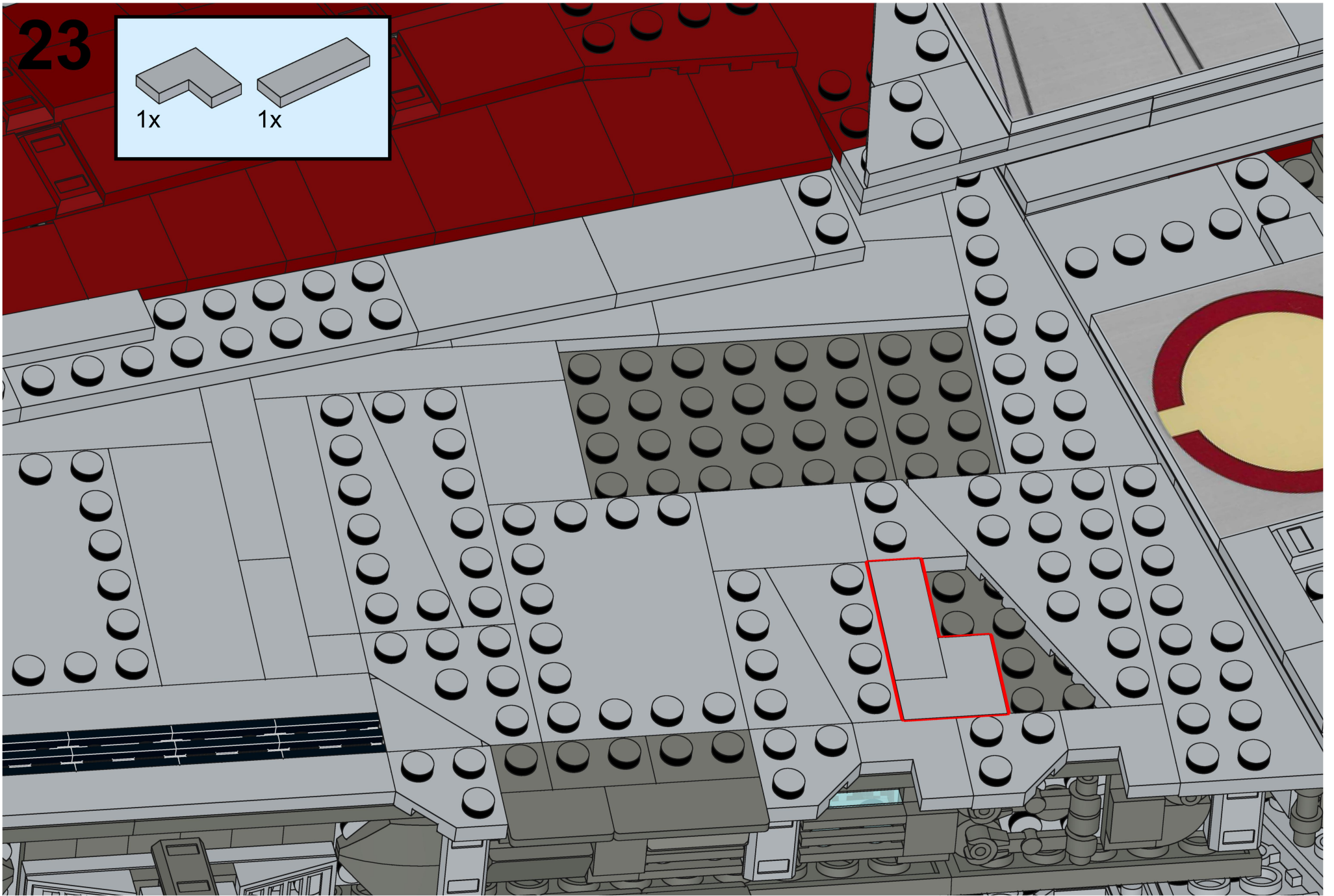
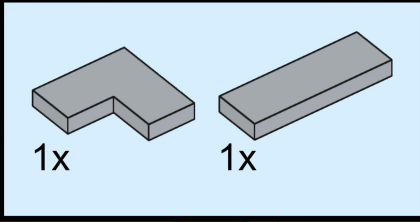

24

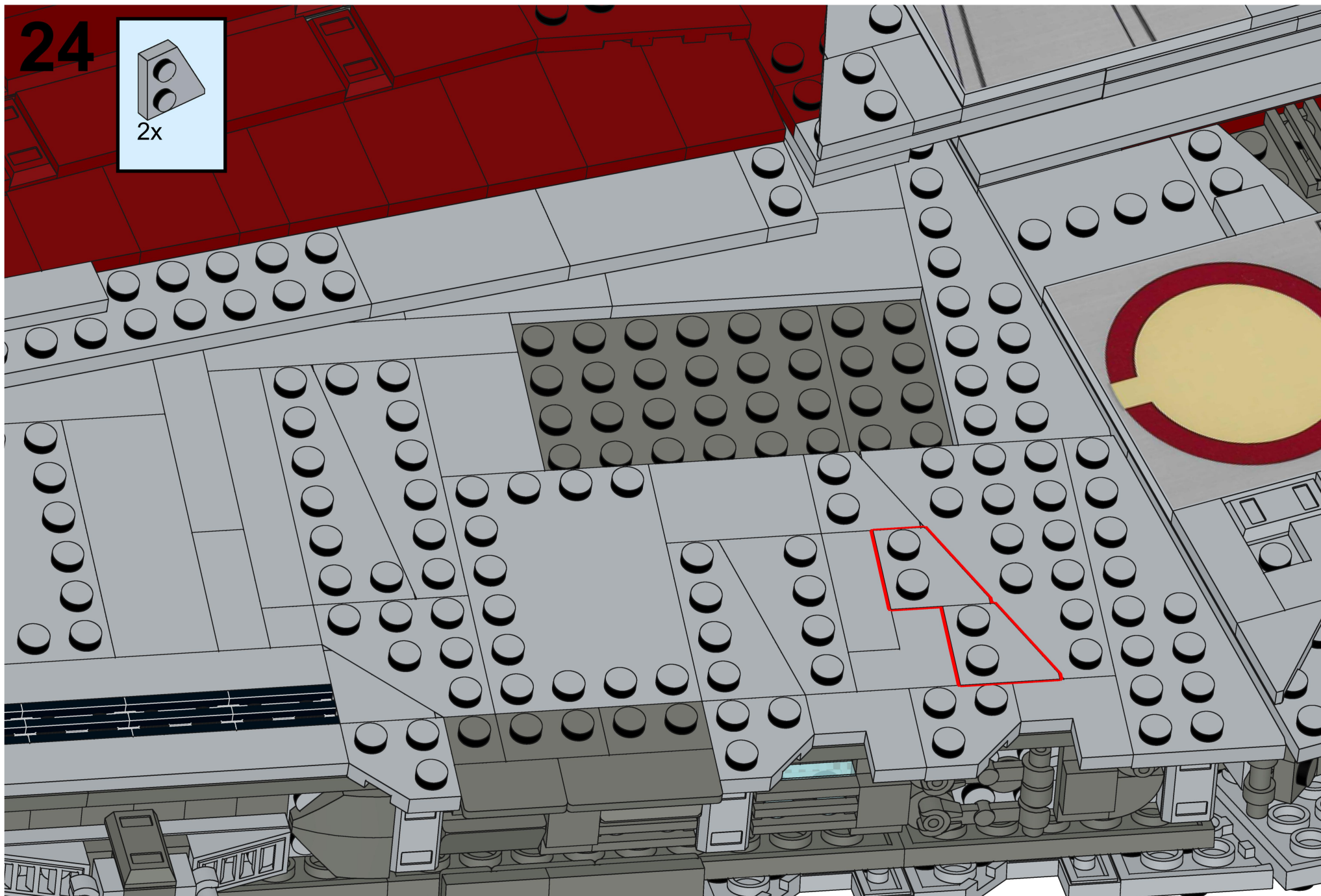
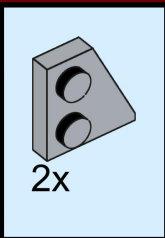

25

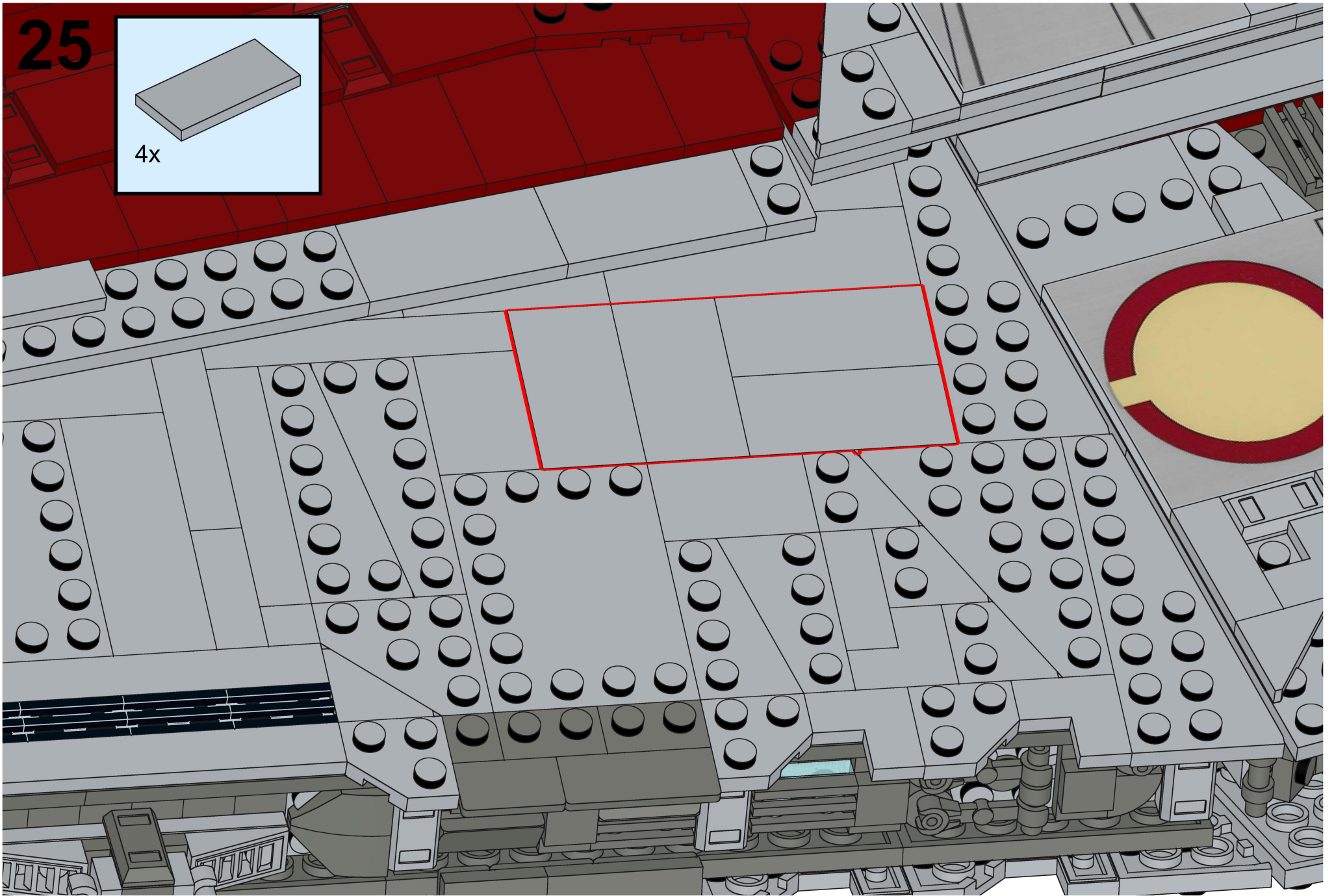
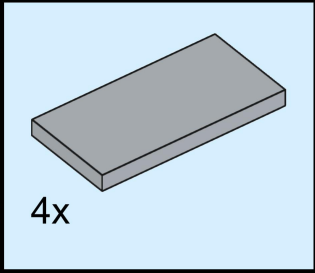



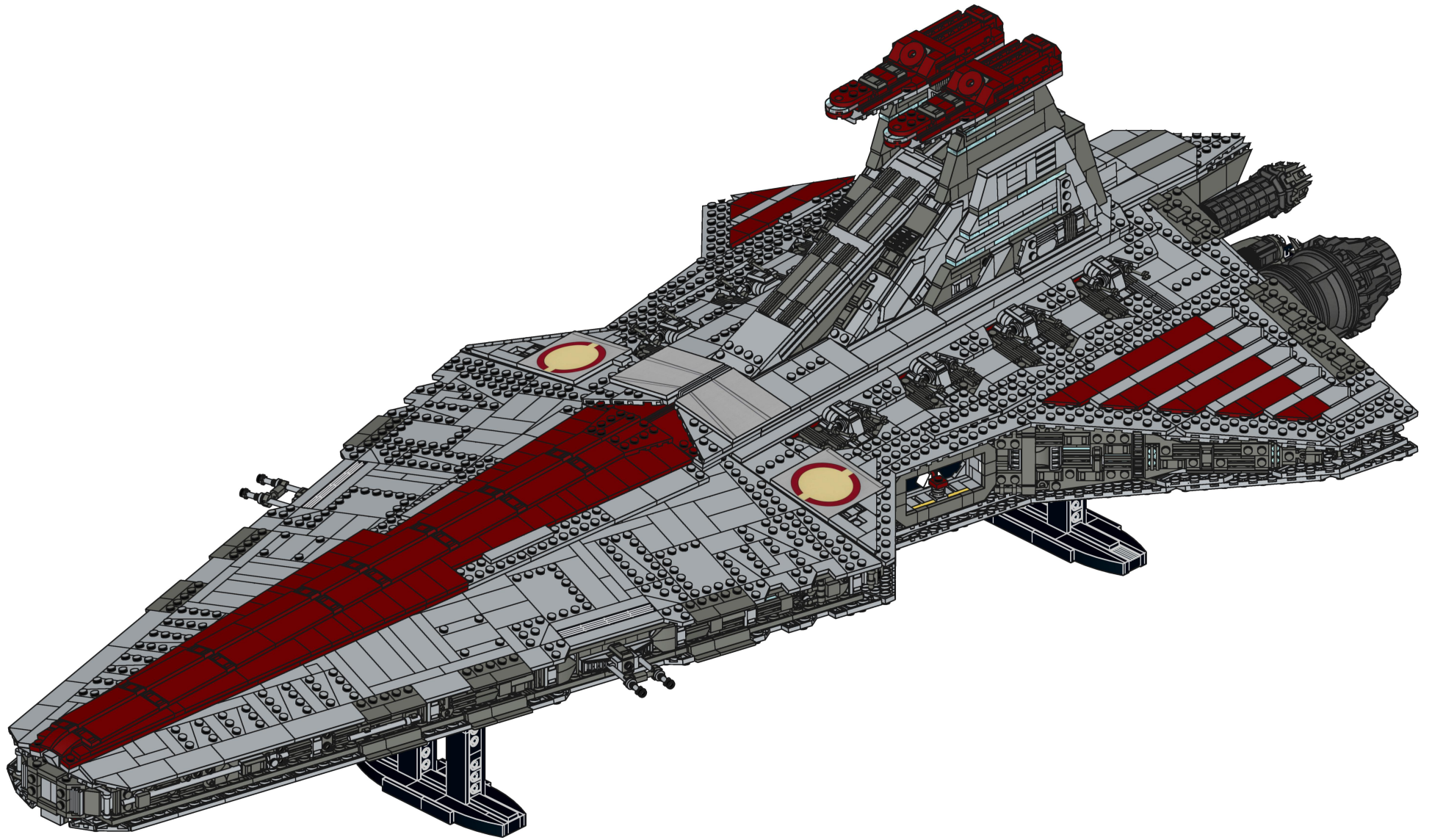

**Bri**  **pando**

**[brixpando.com](http://brixpando.com)**