

Bri  **pando**

brixpando.com

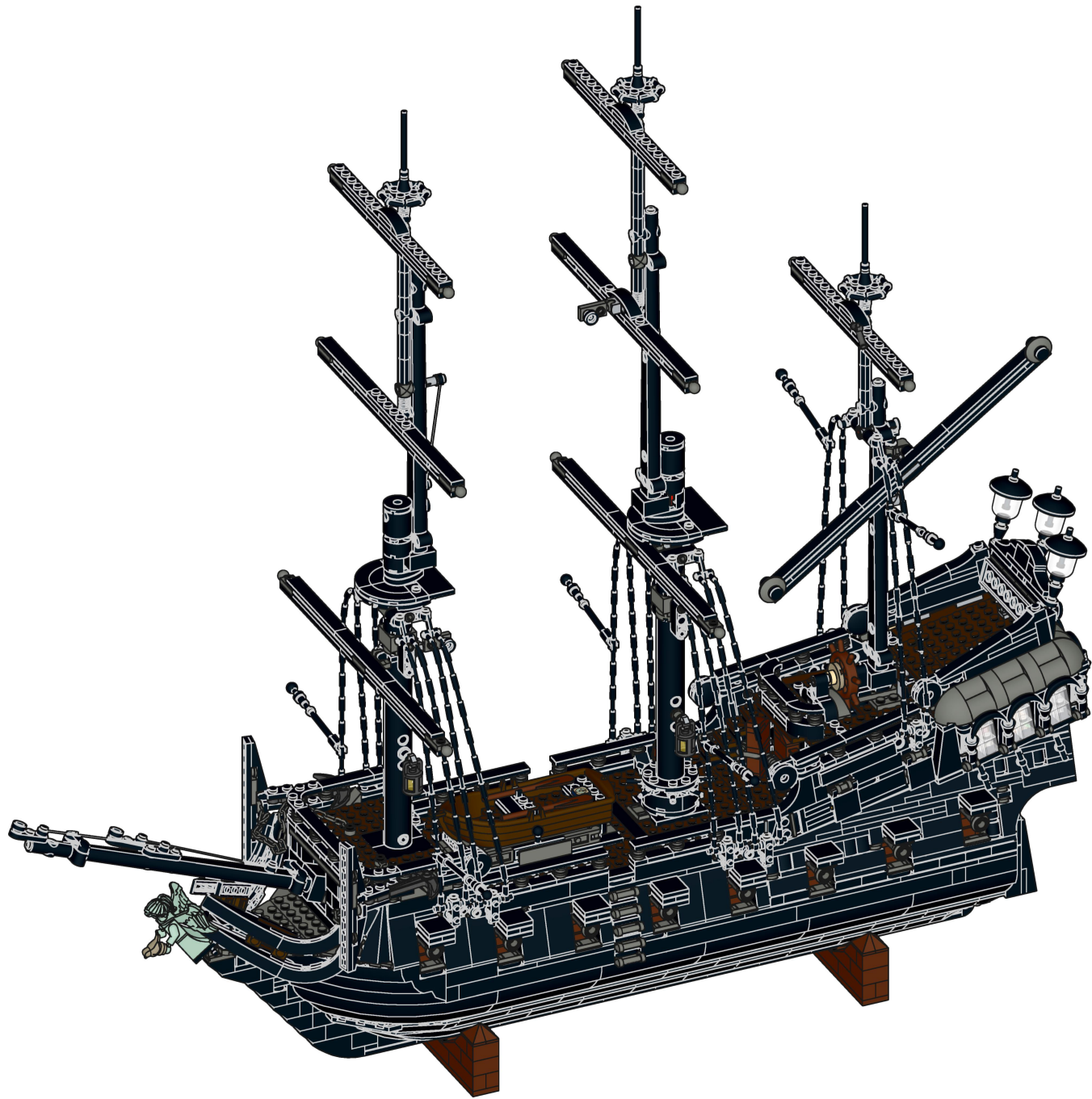

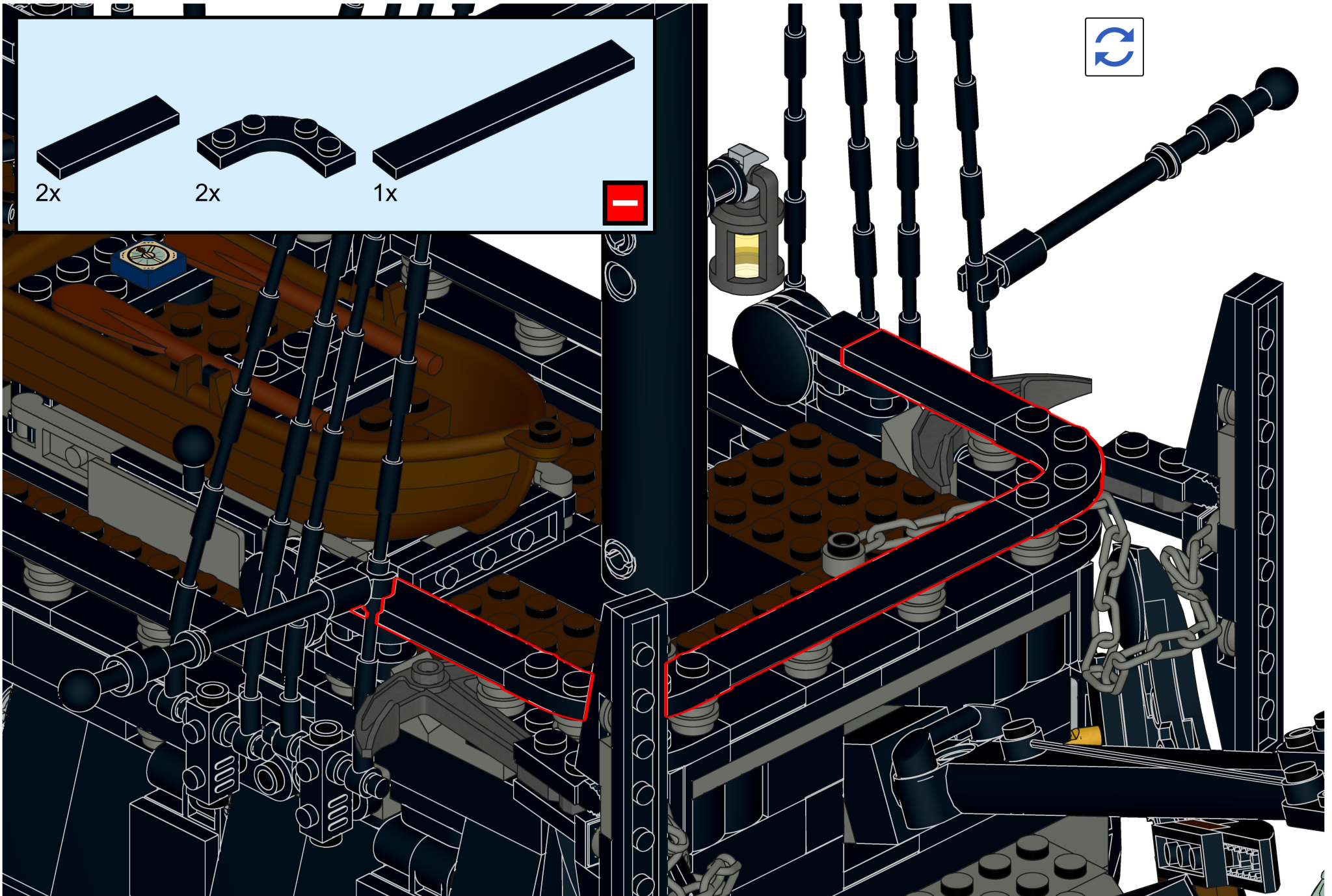

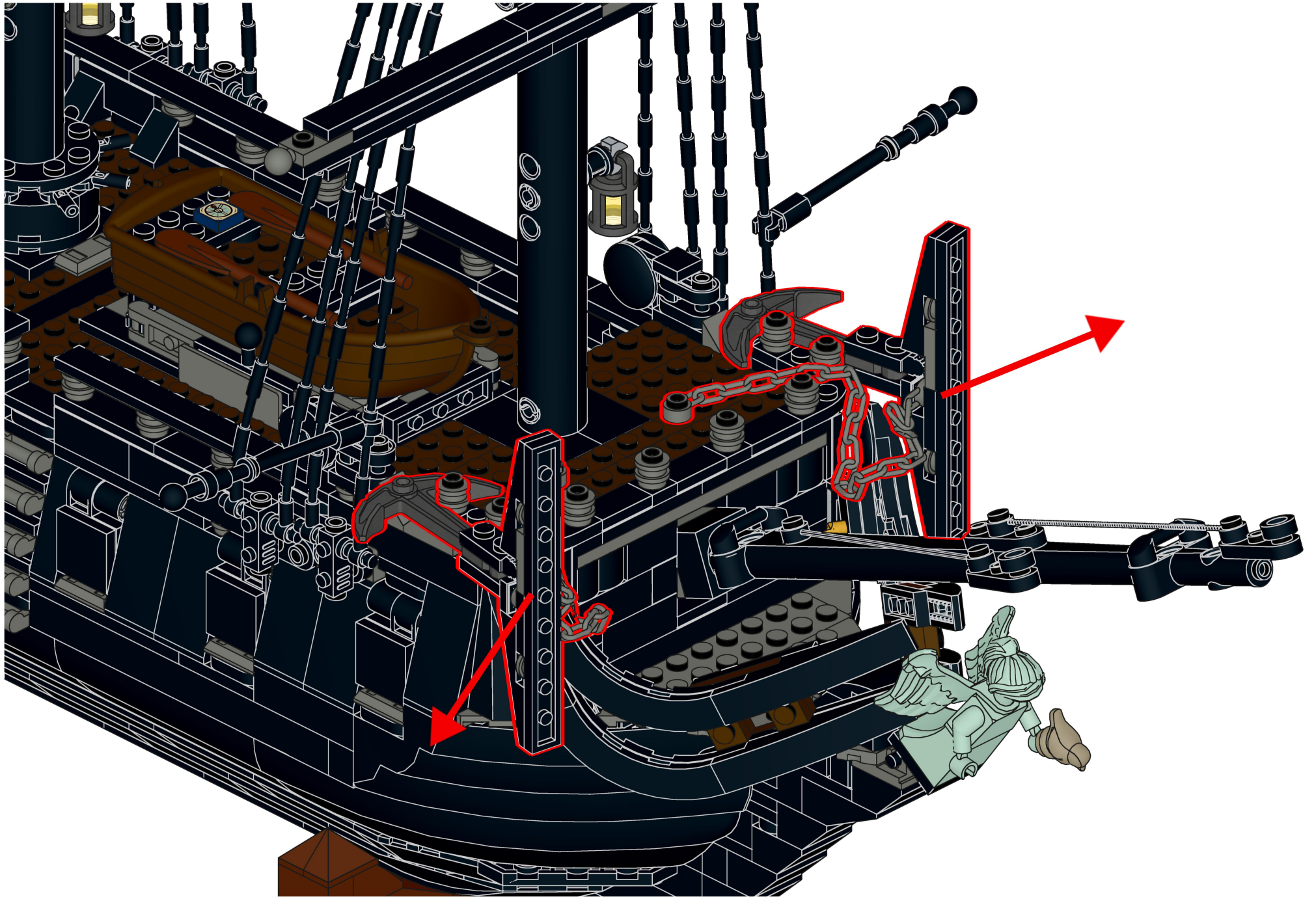

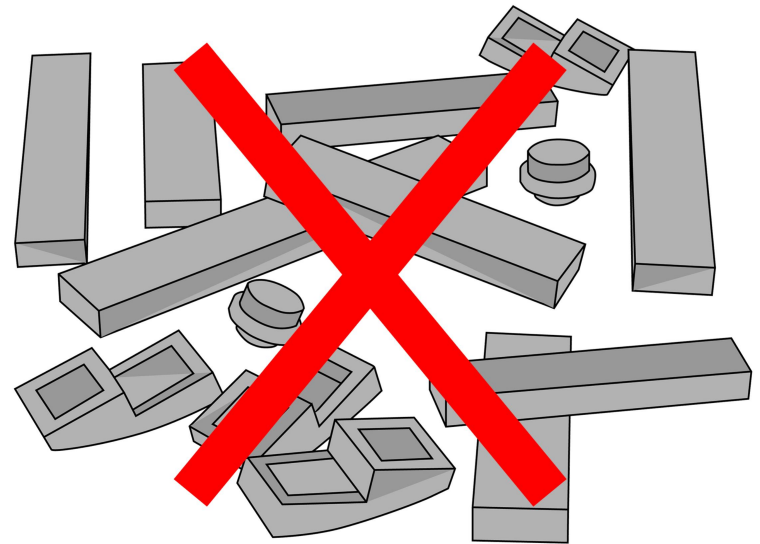
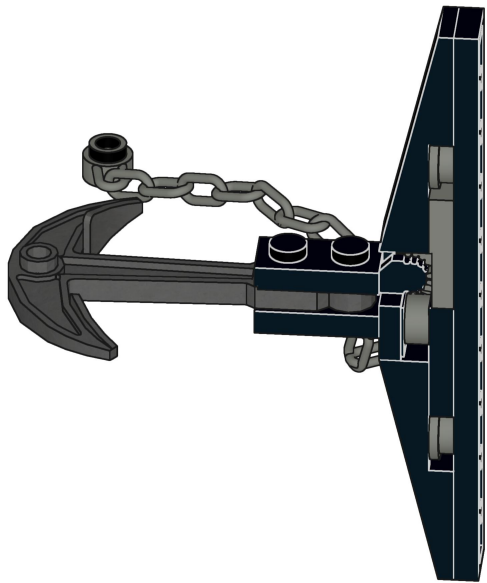
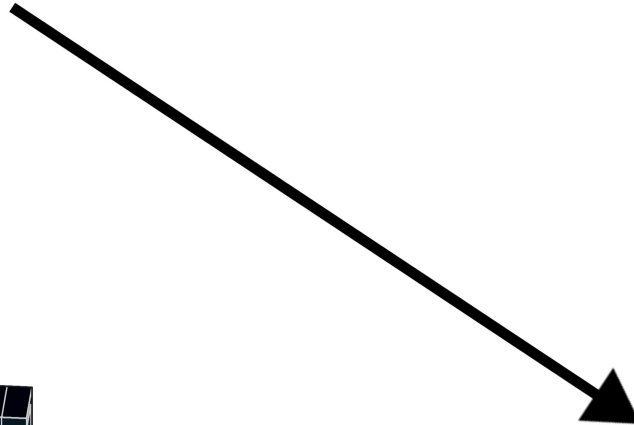
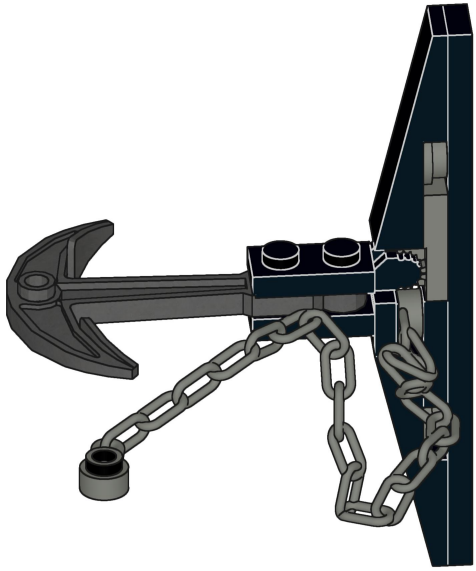

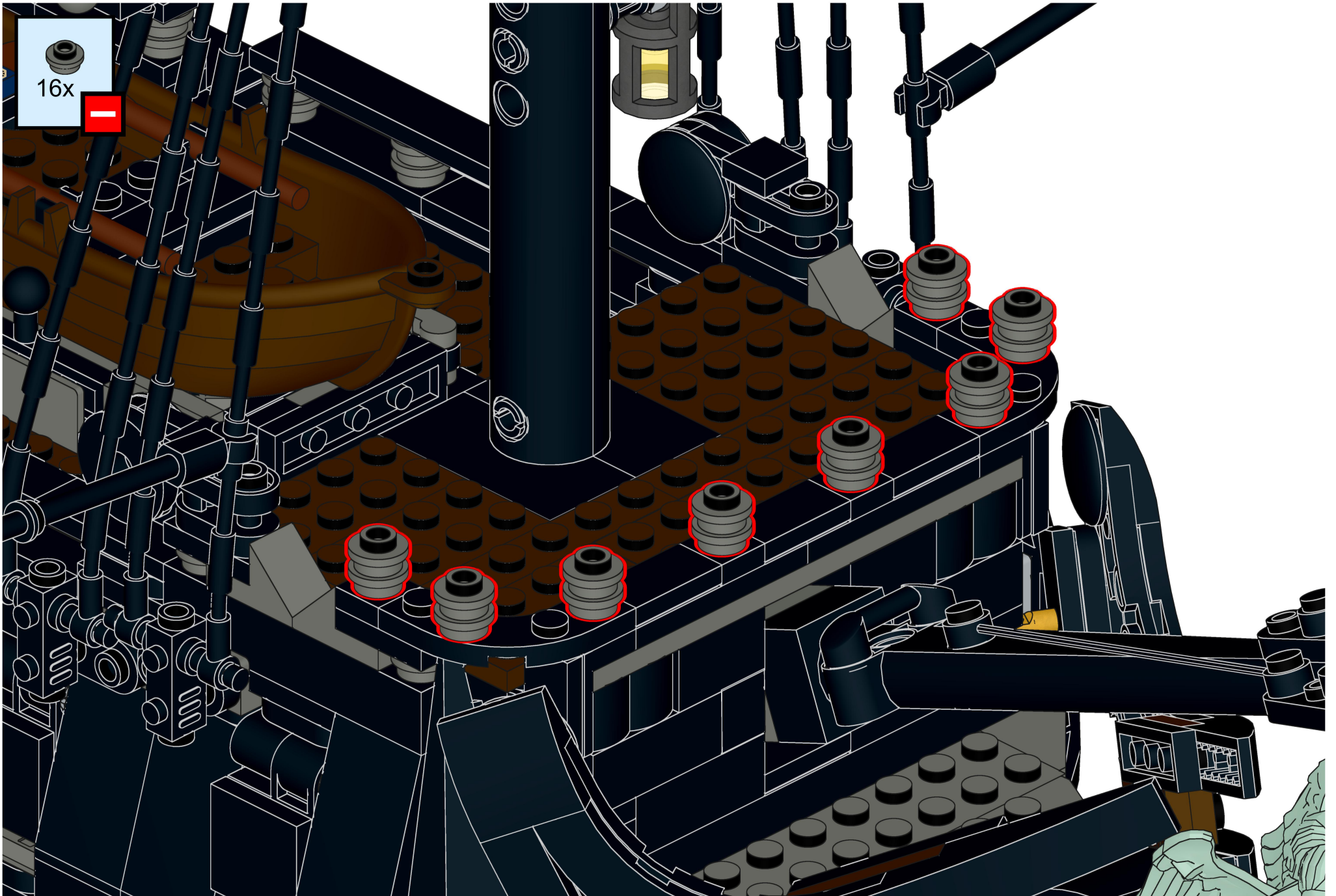

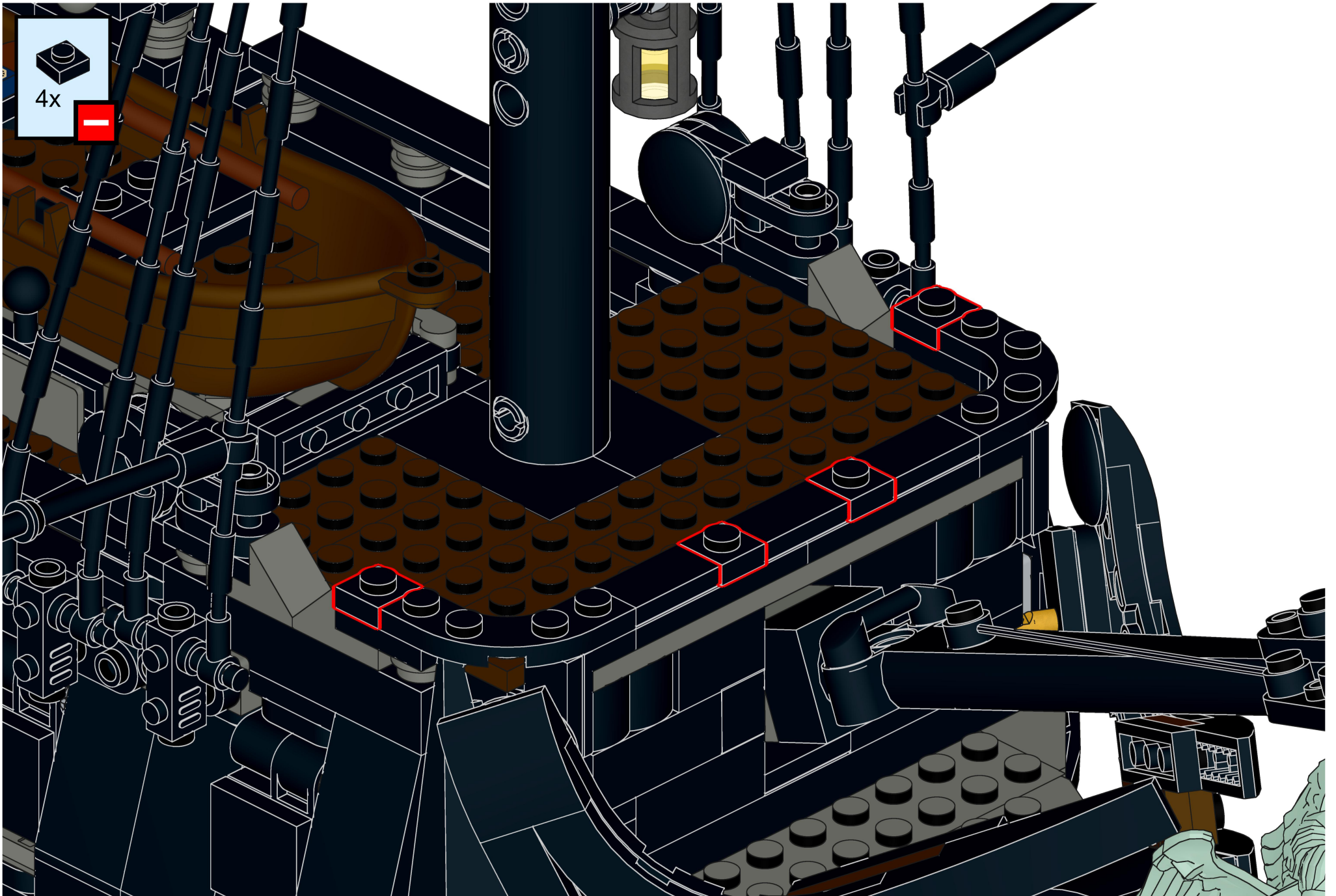

2x

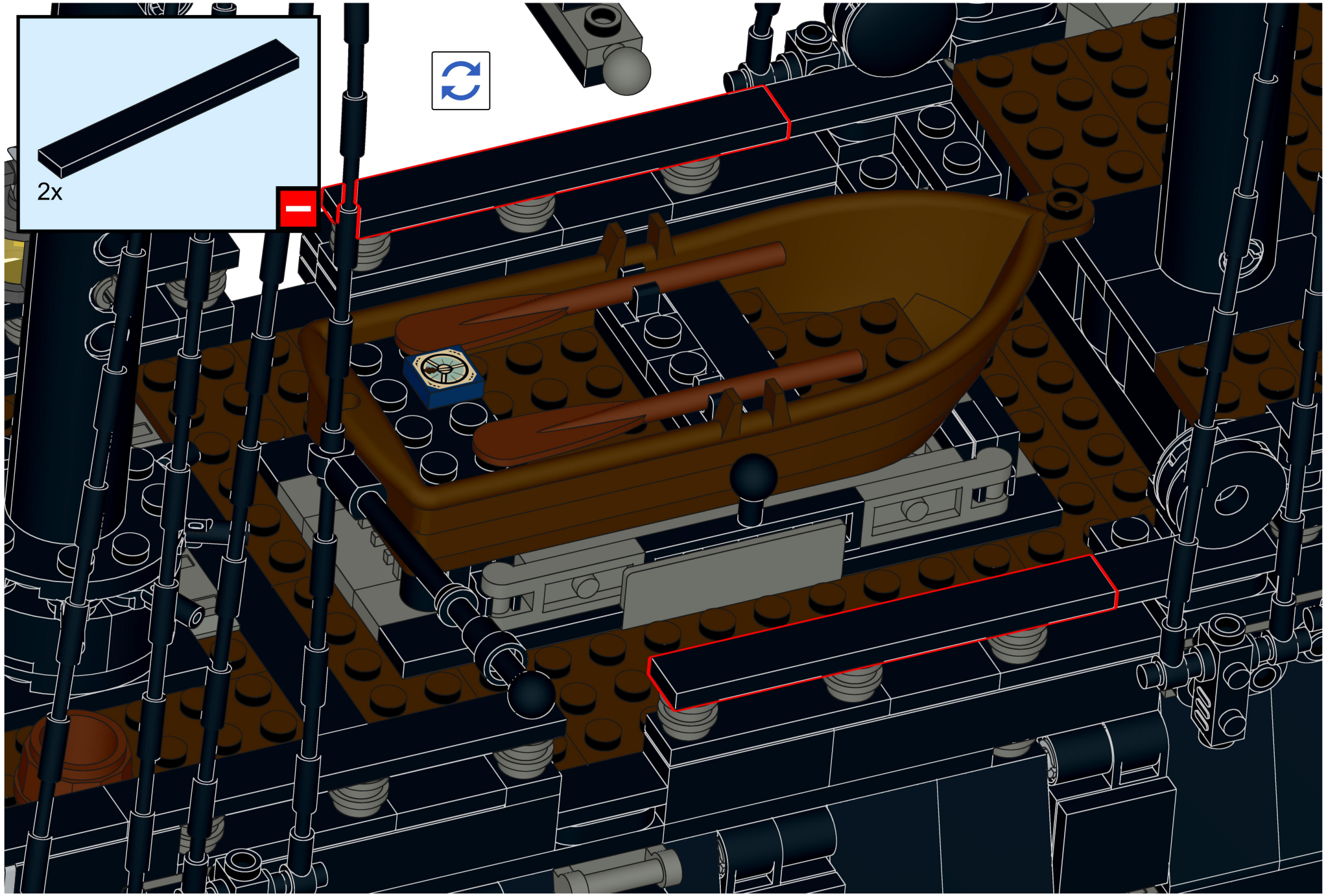

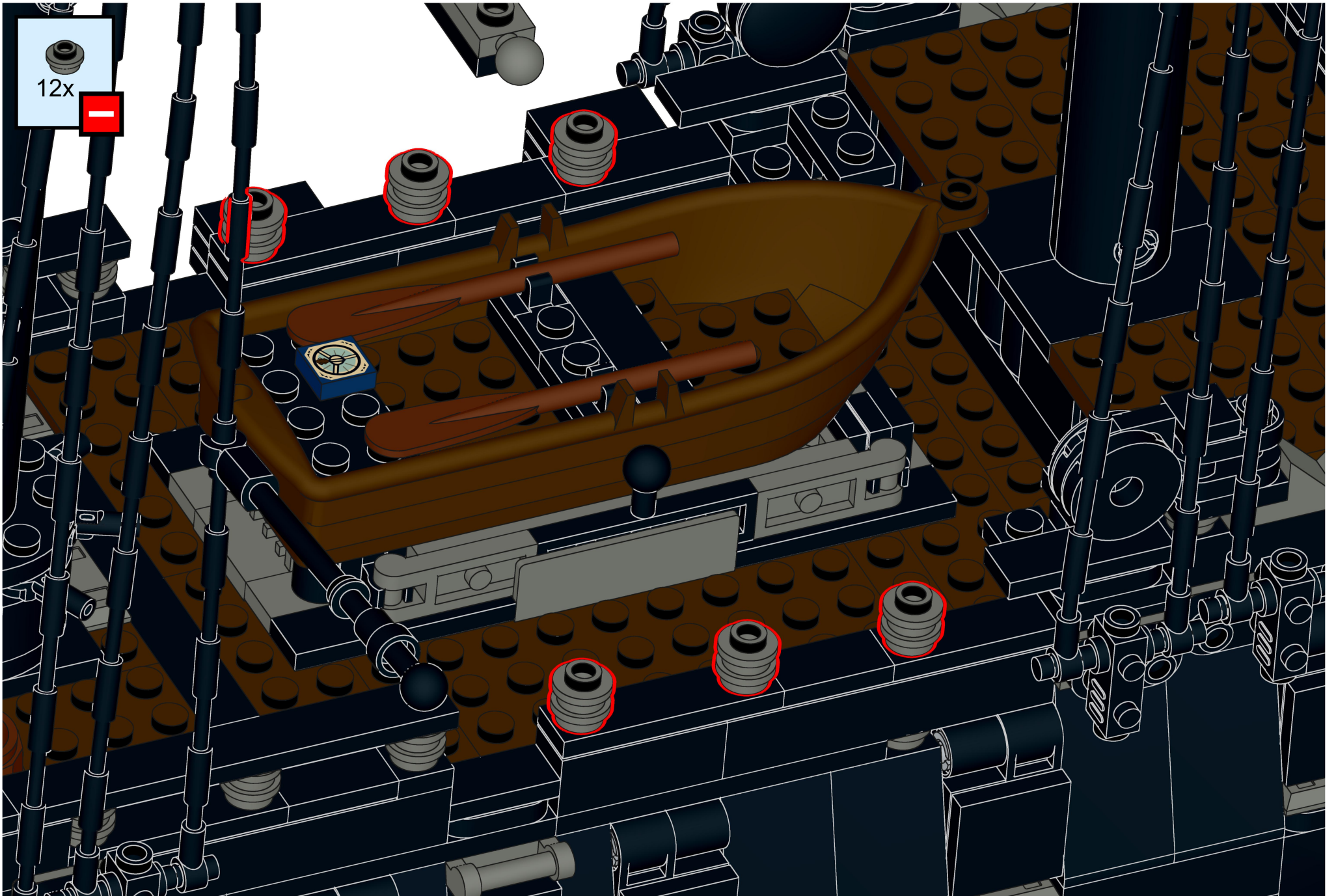

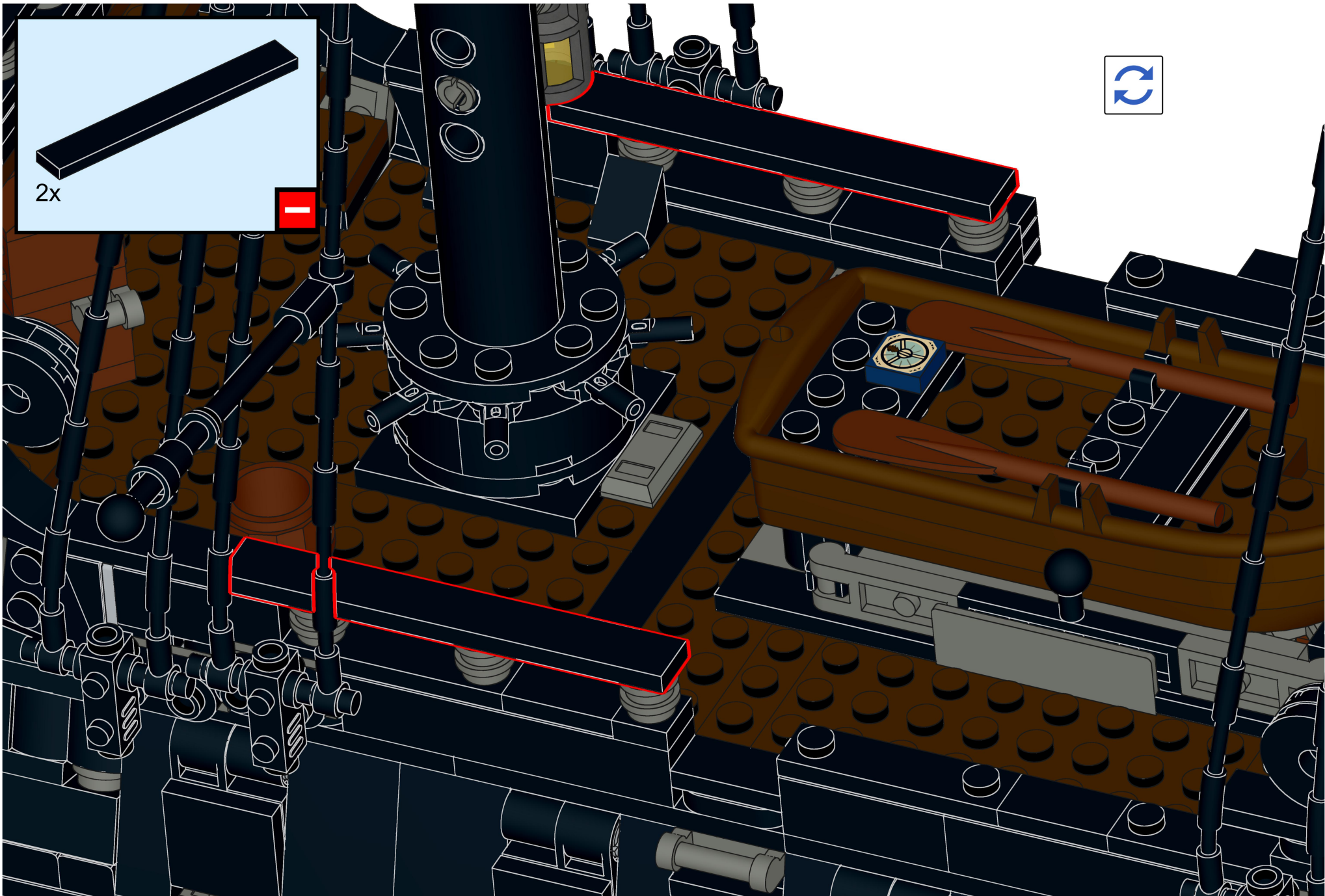

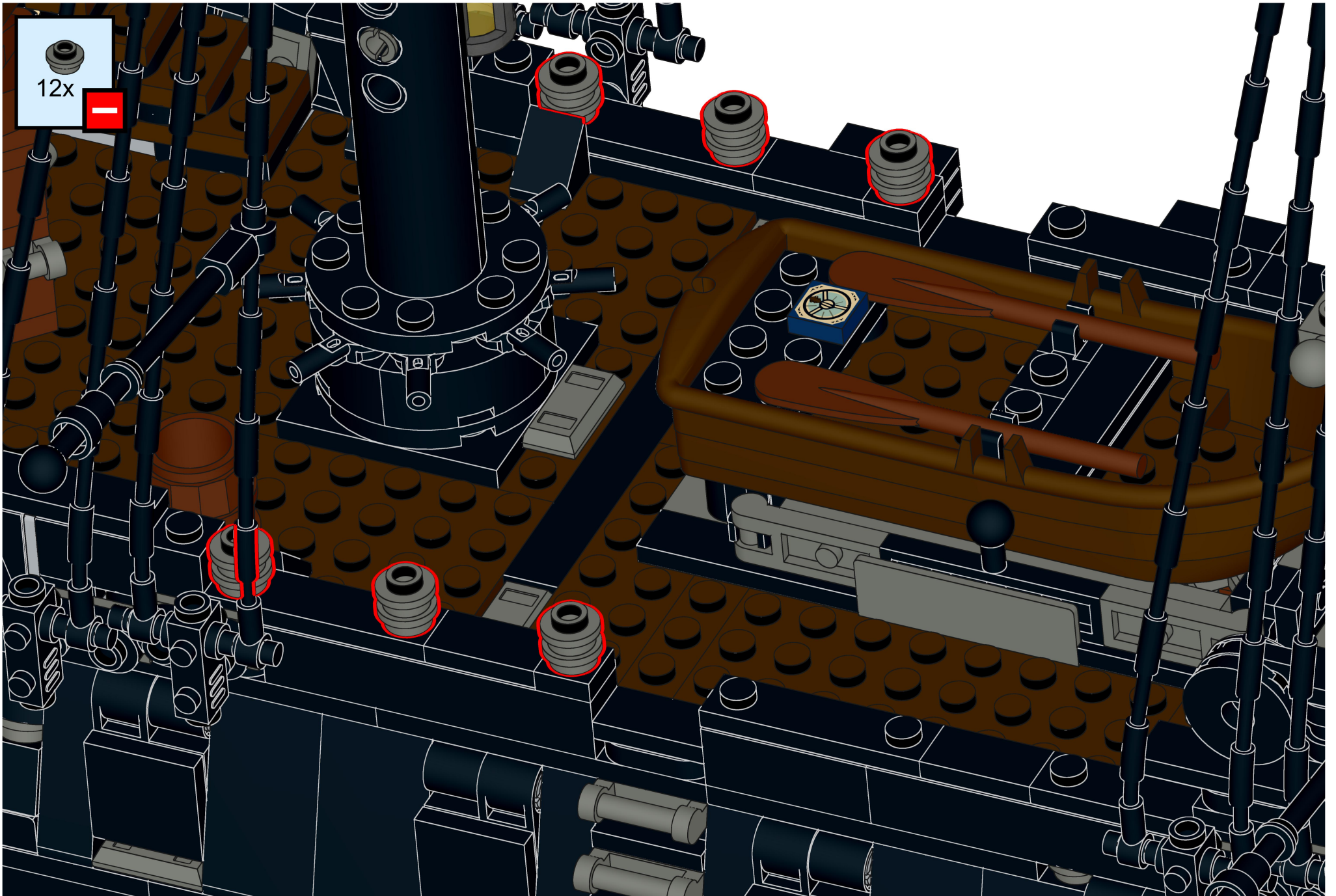

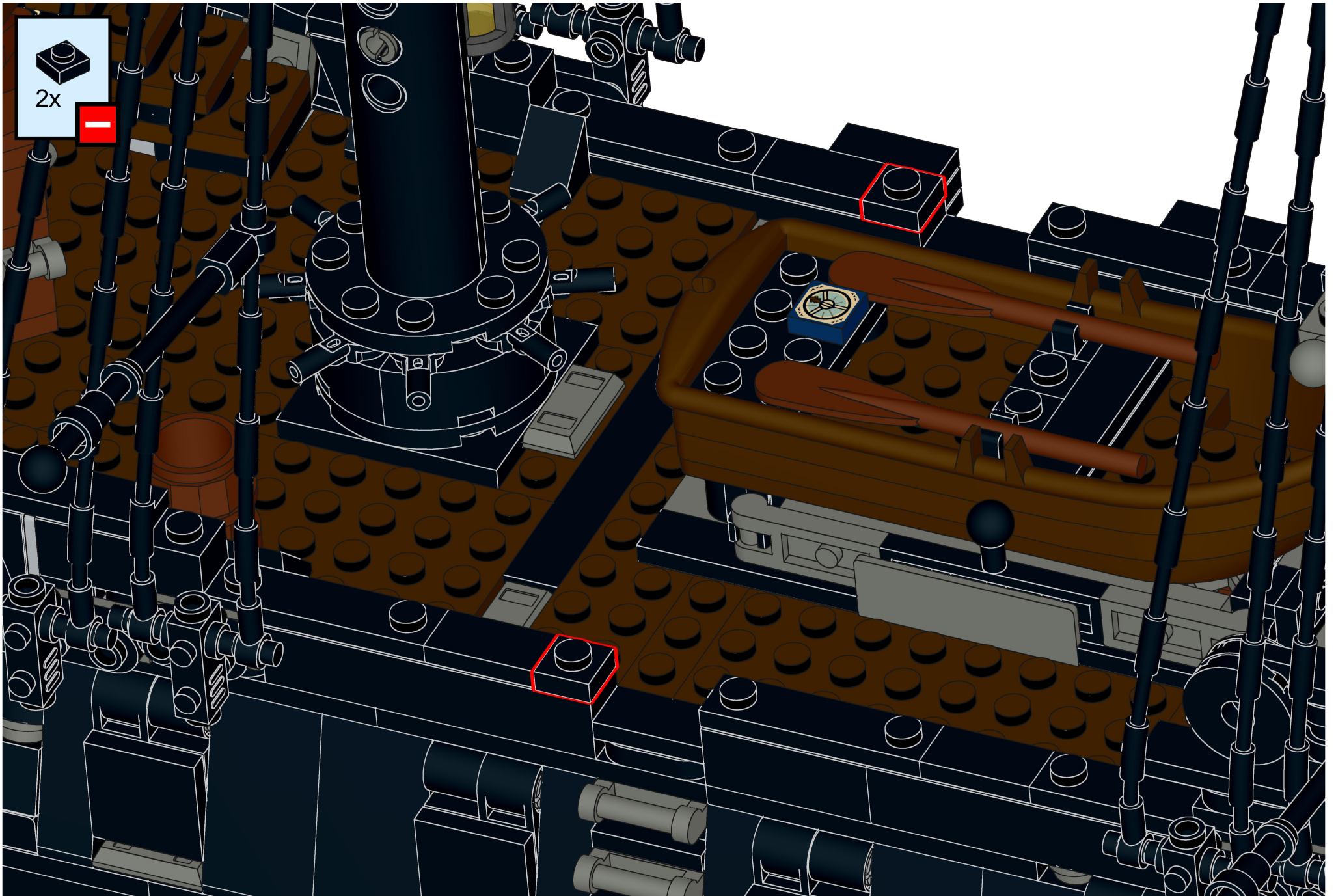

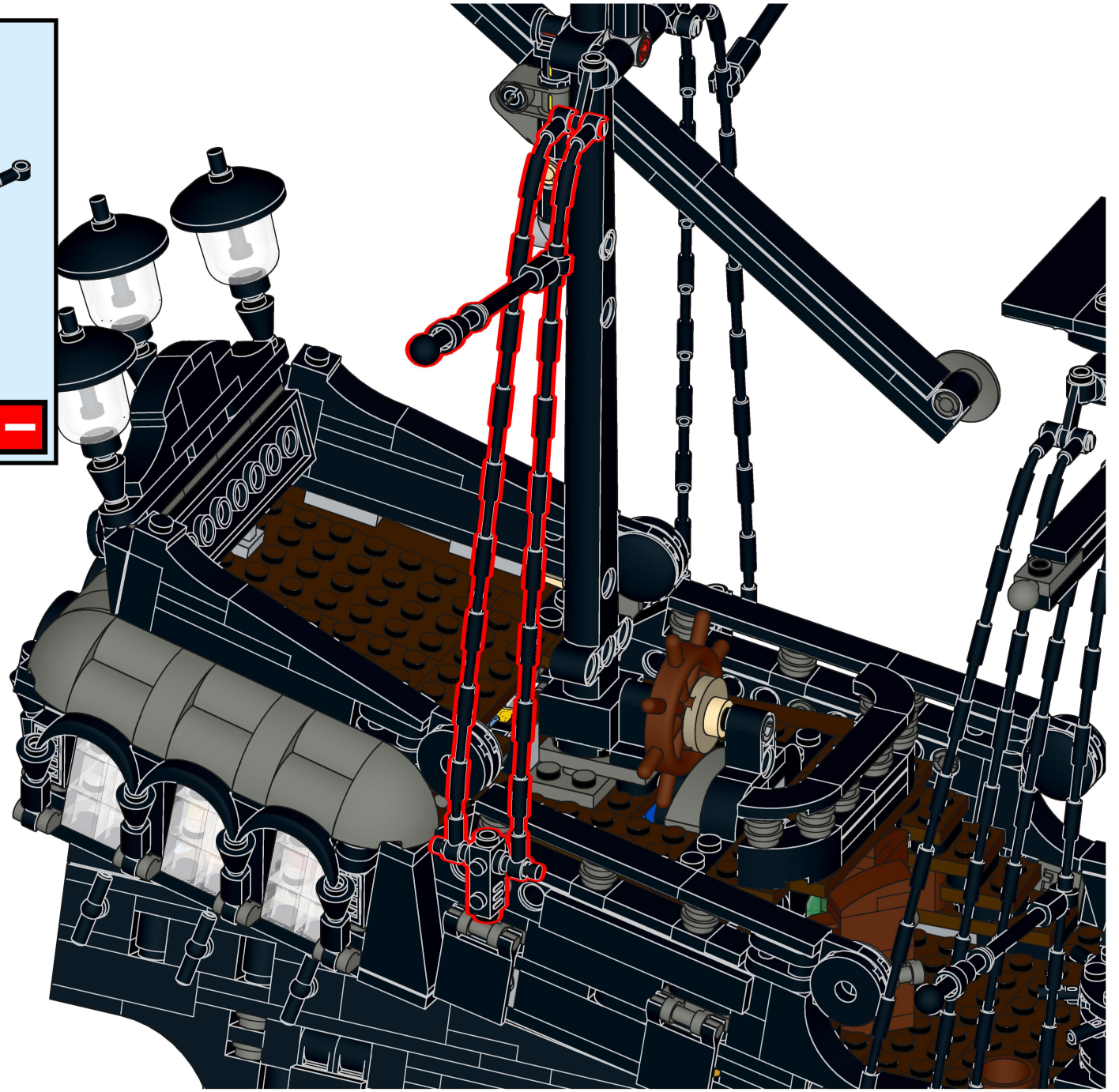
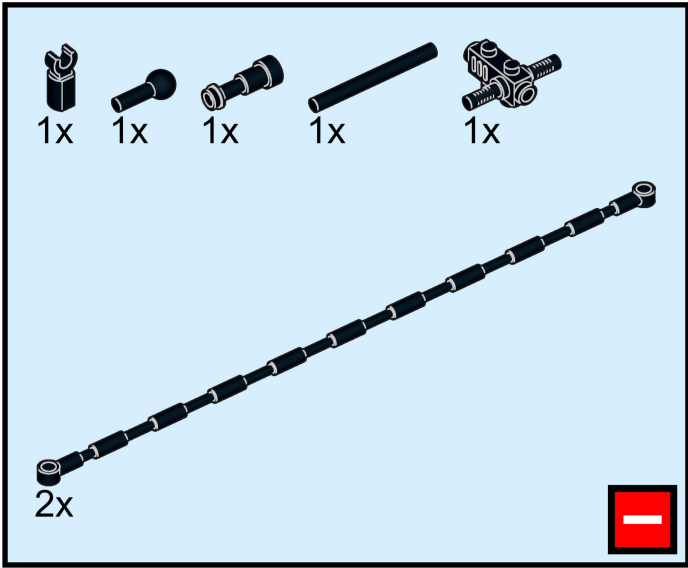

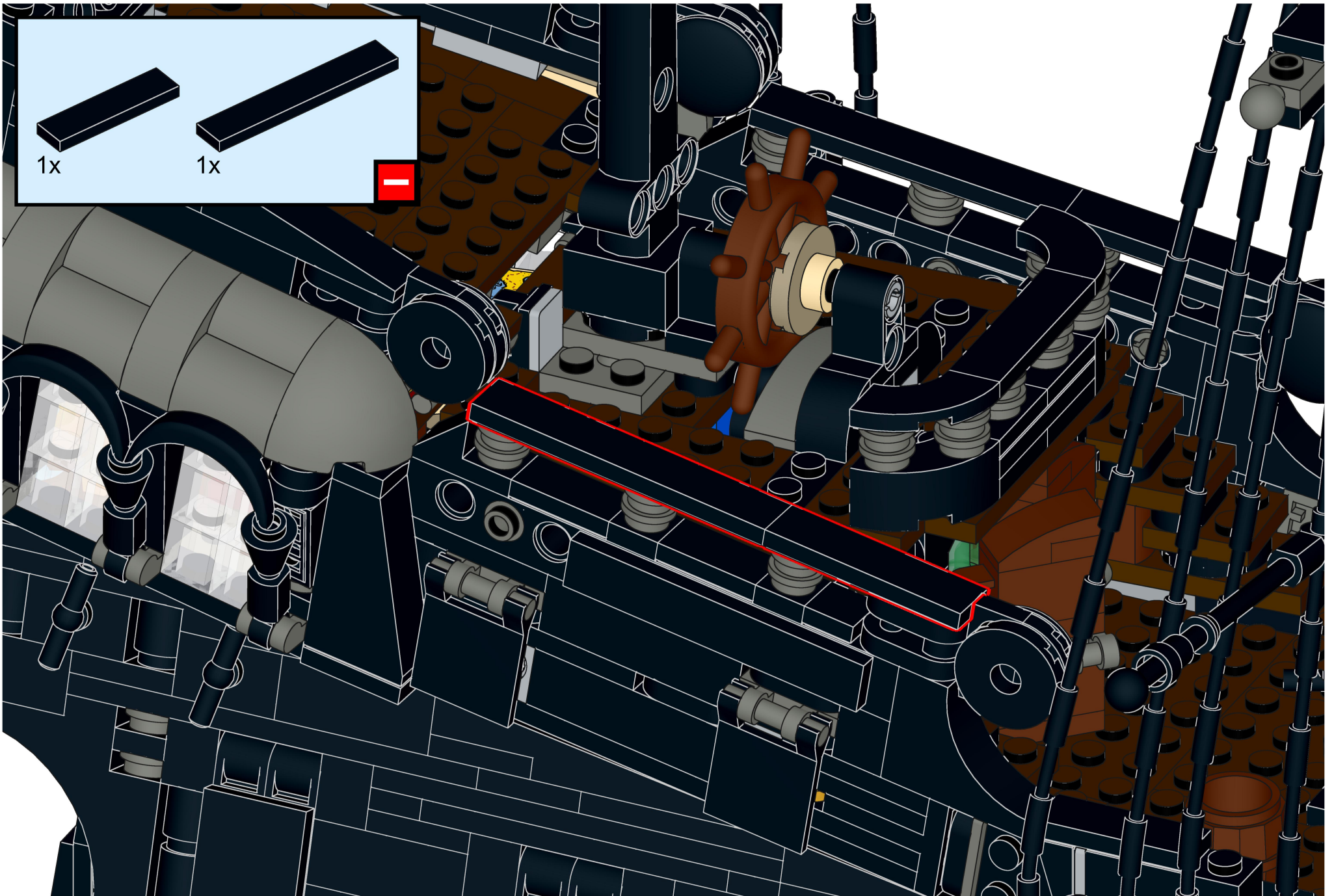

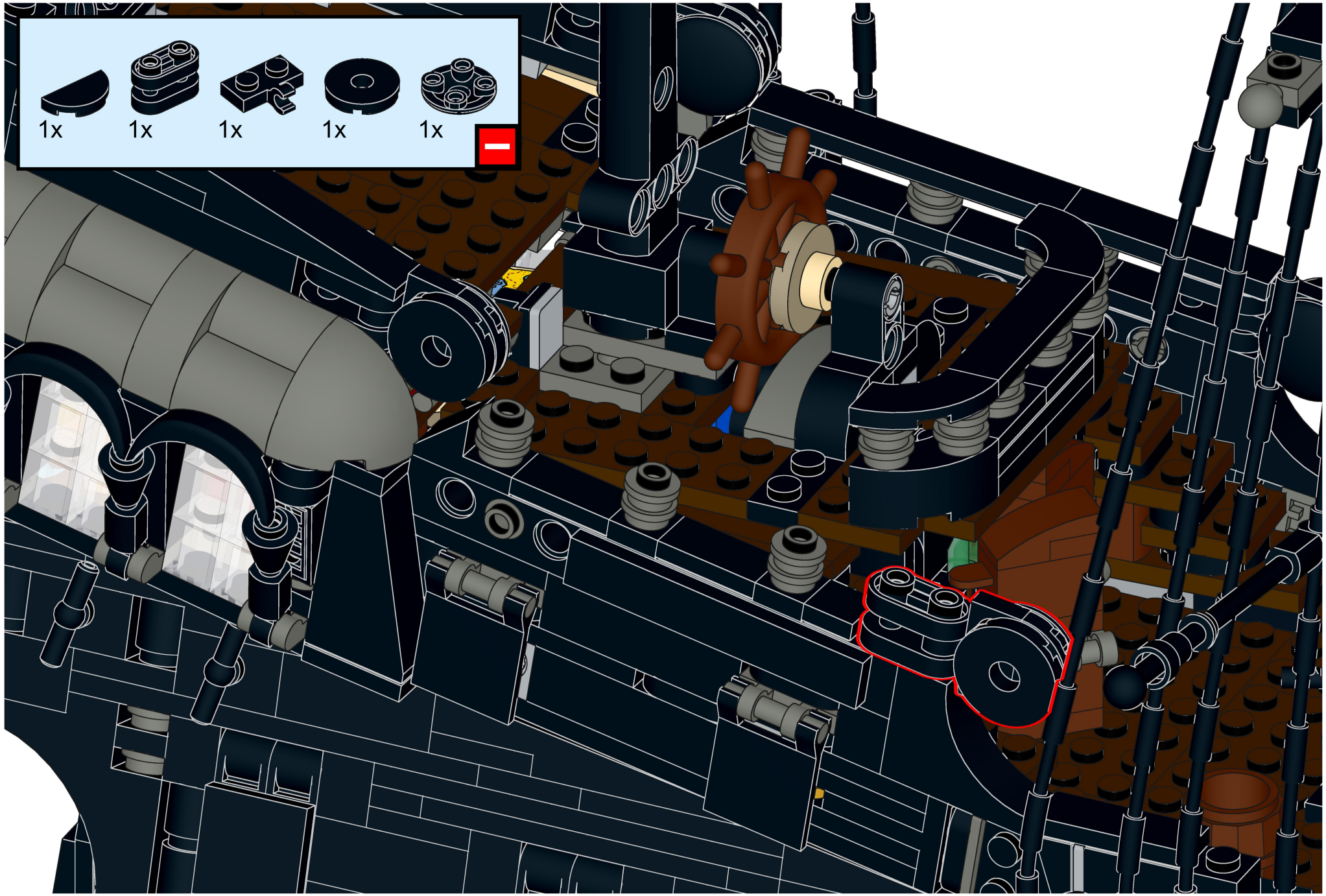

1x 1x 1x 1x 1x

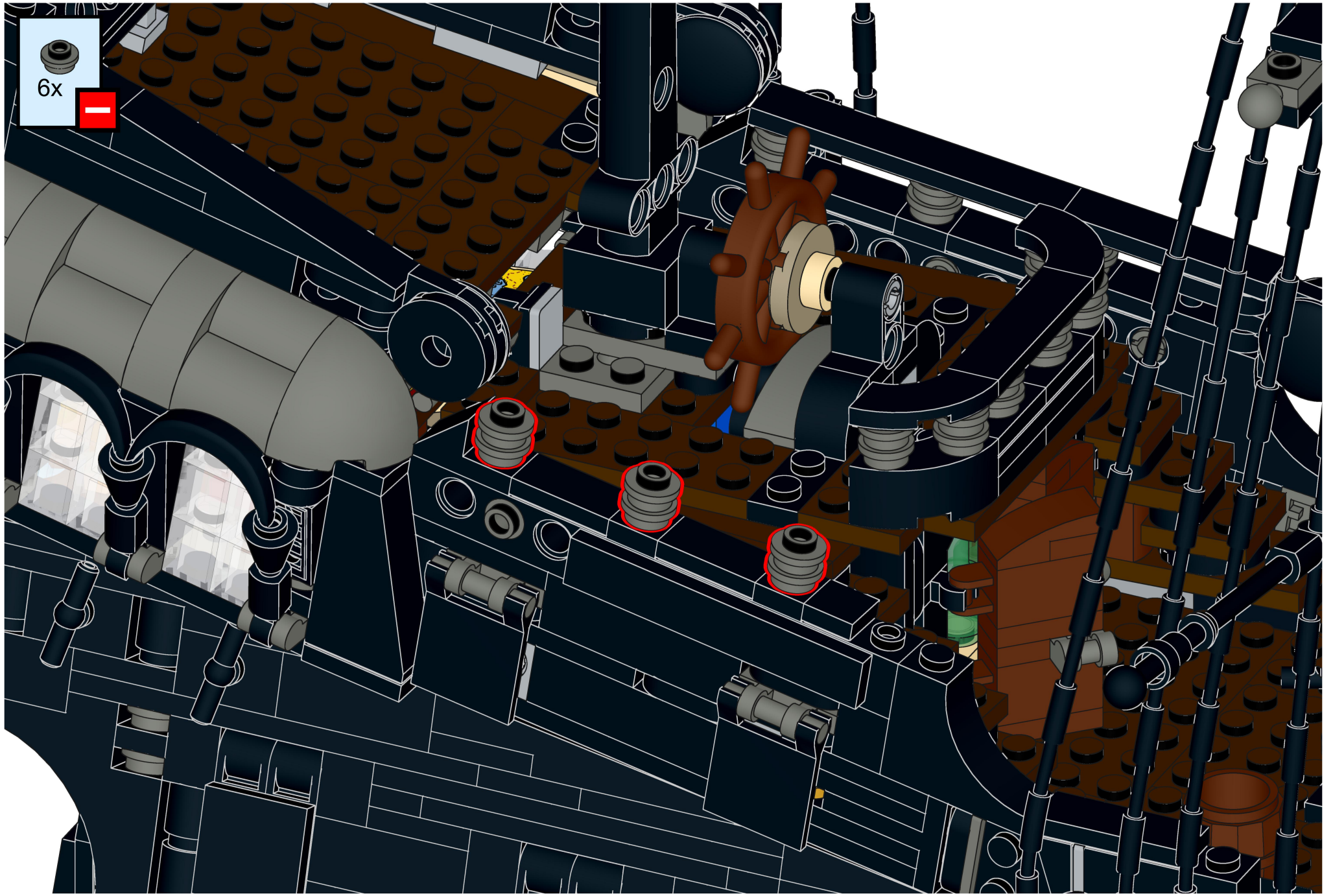

6x

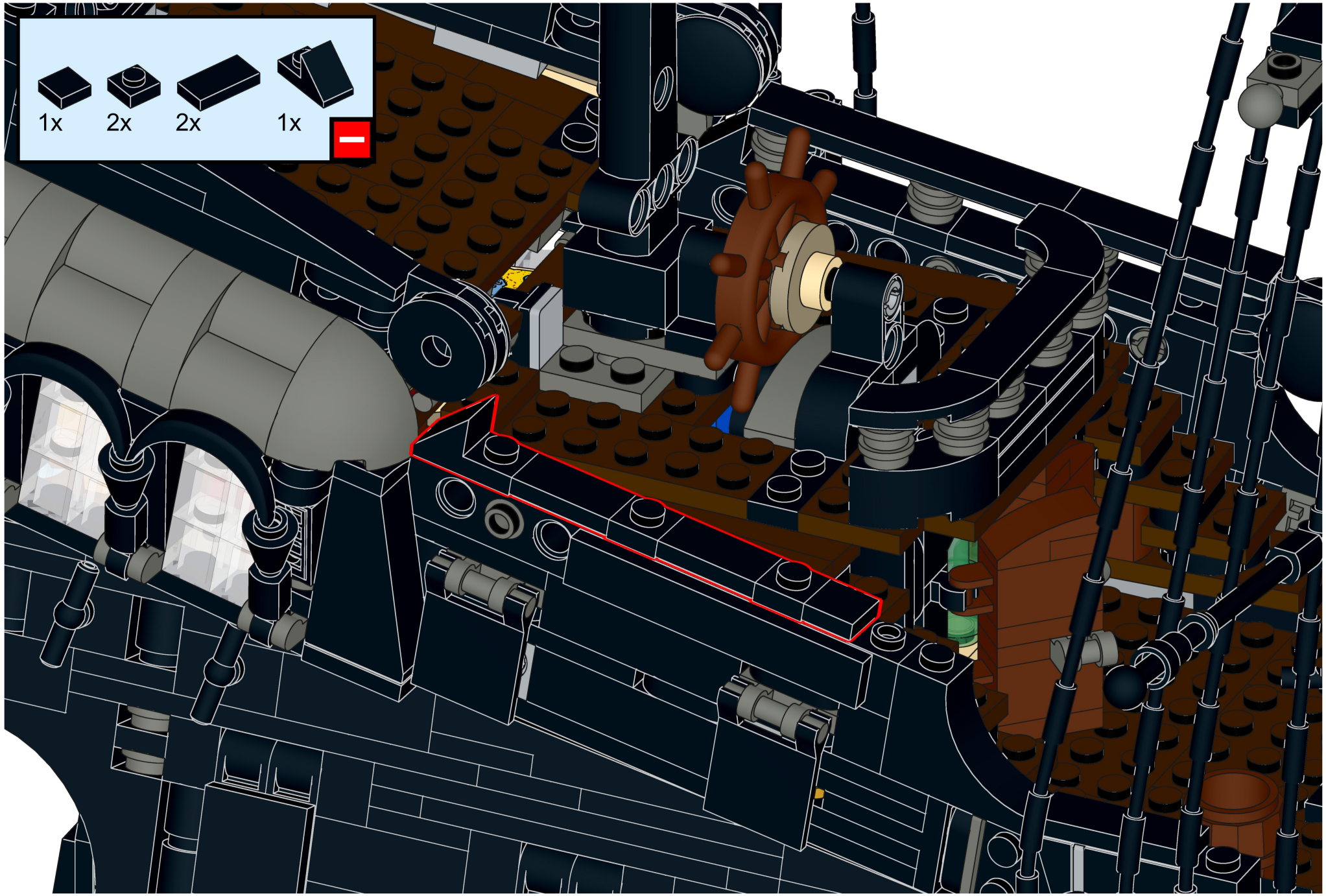

1x



2x



2x



1x



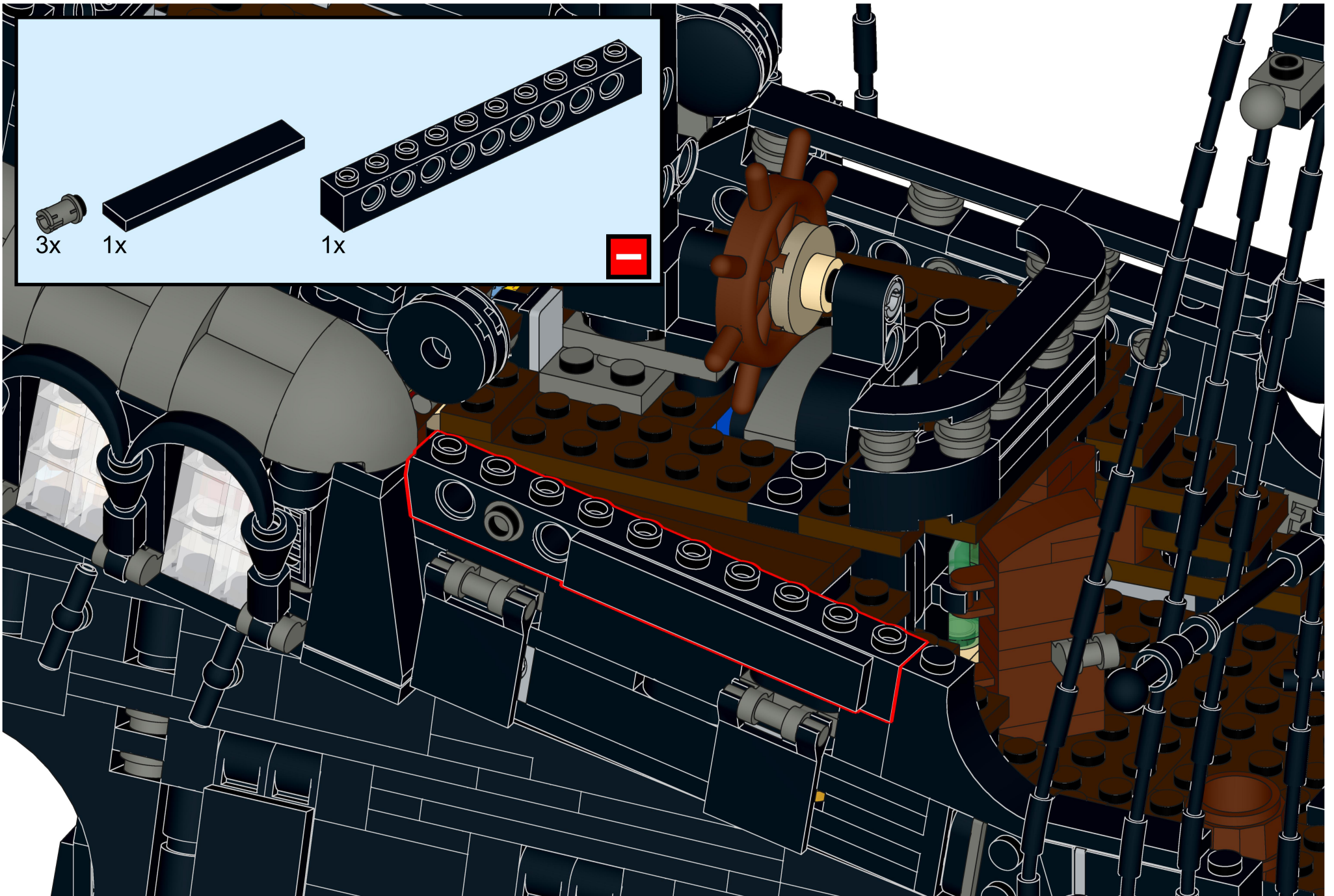

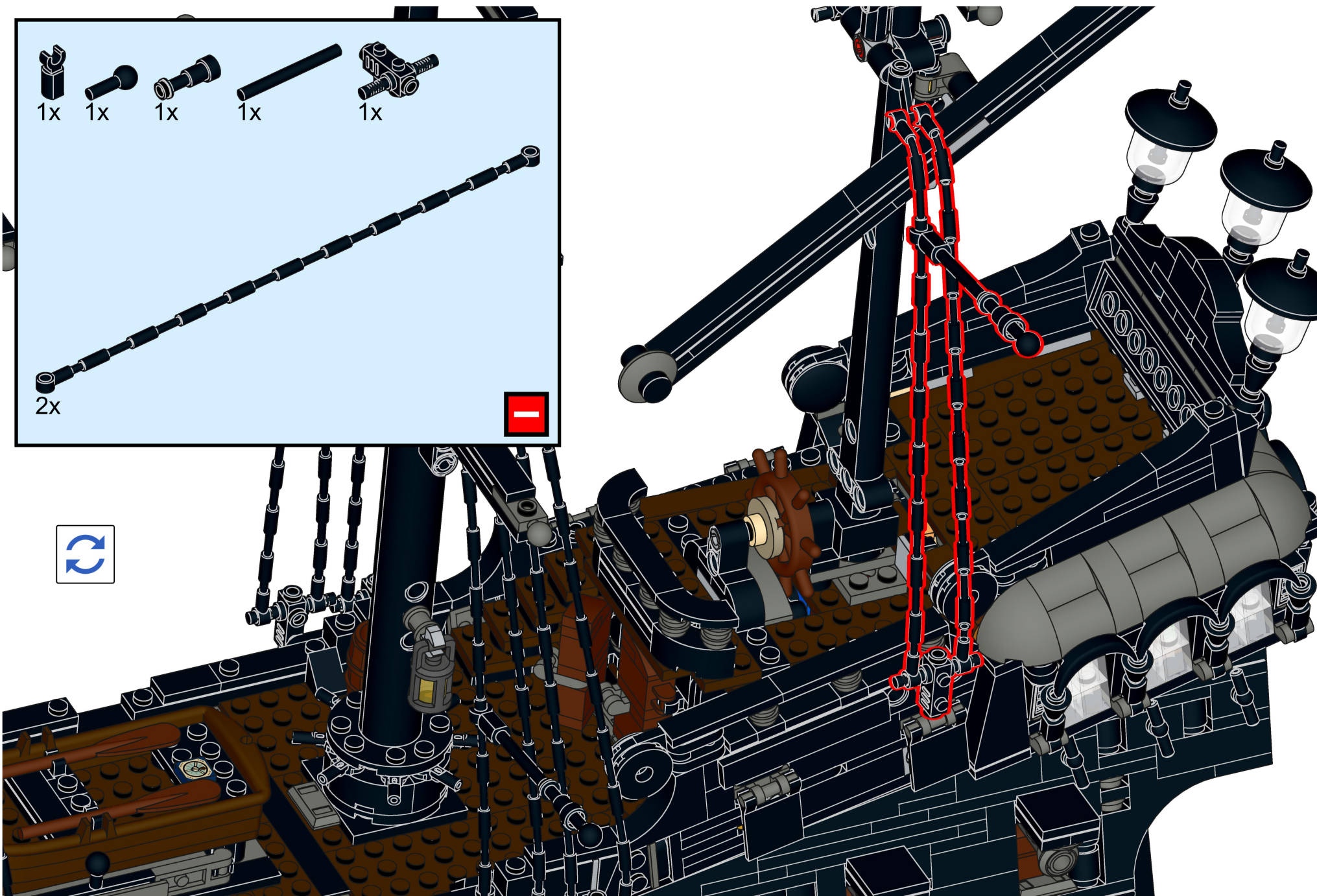
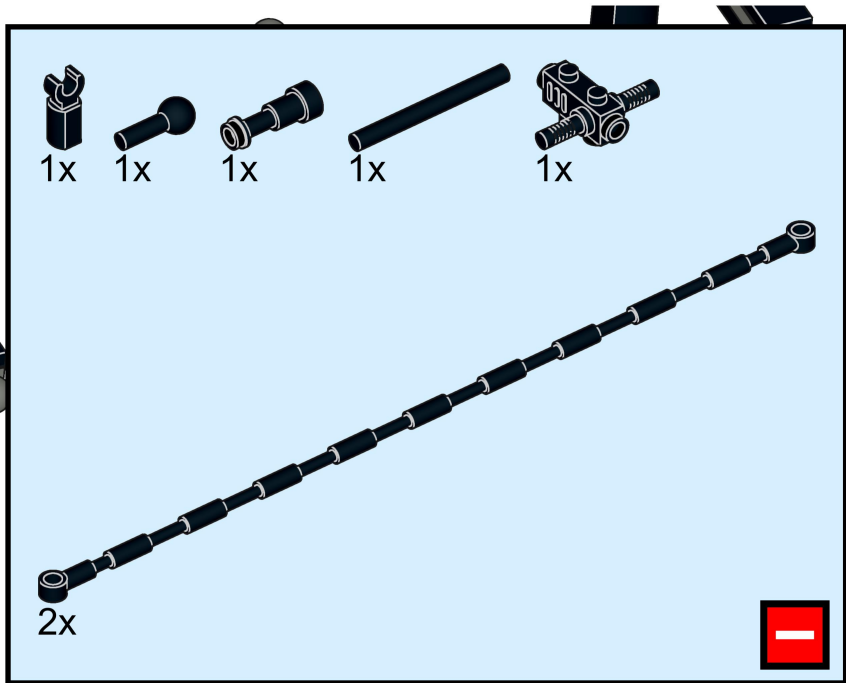

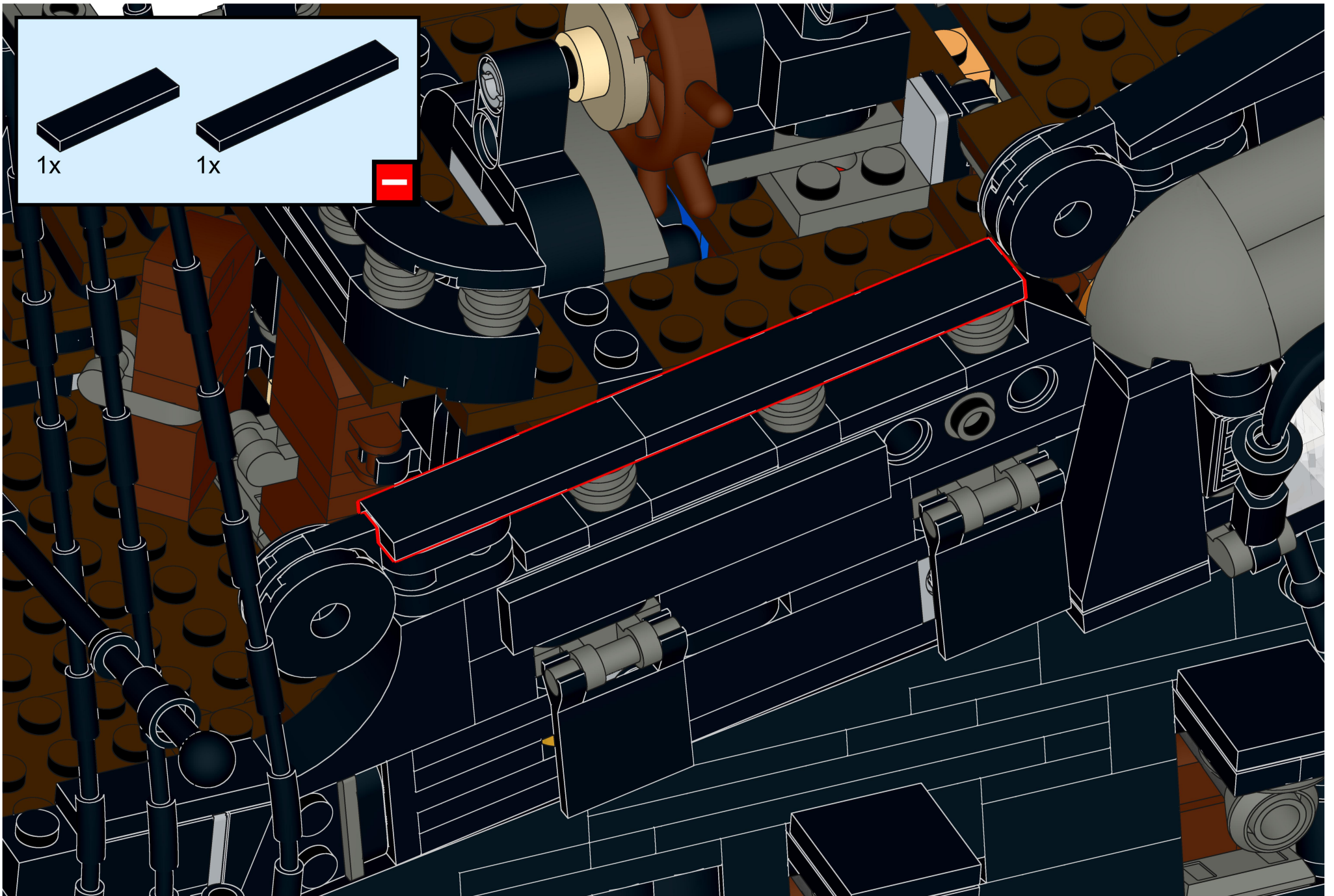

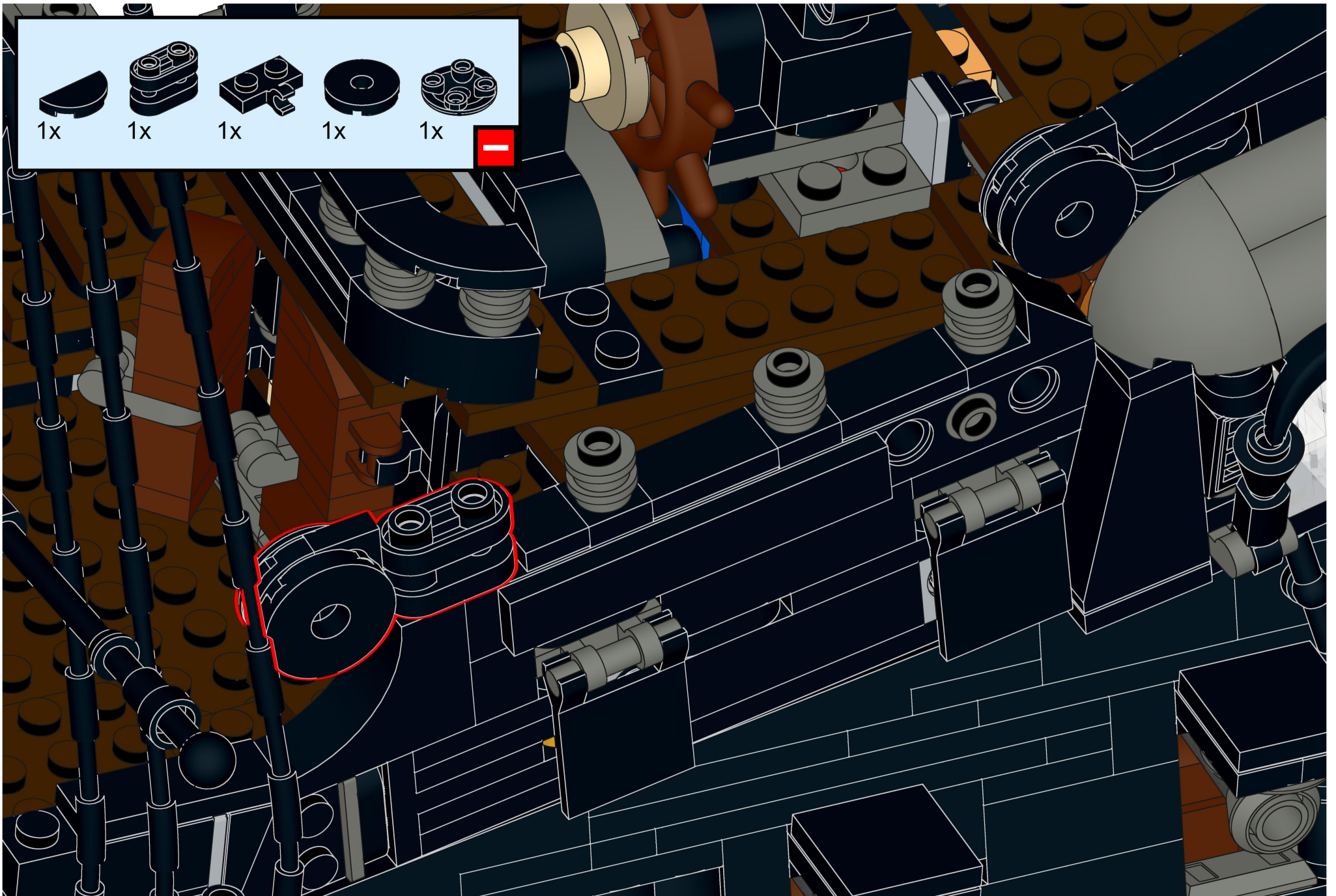

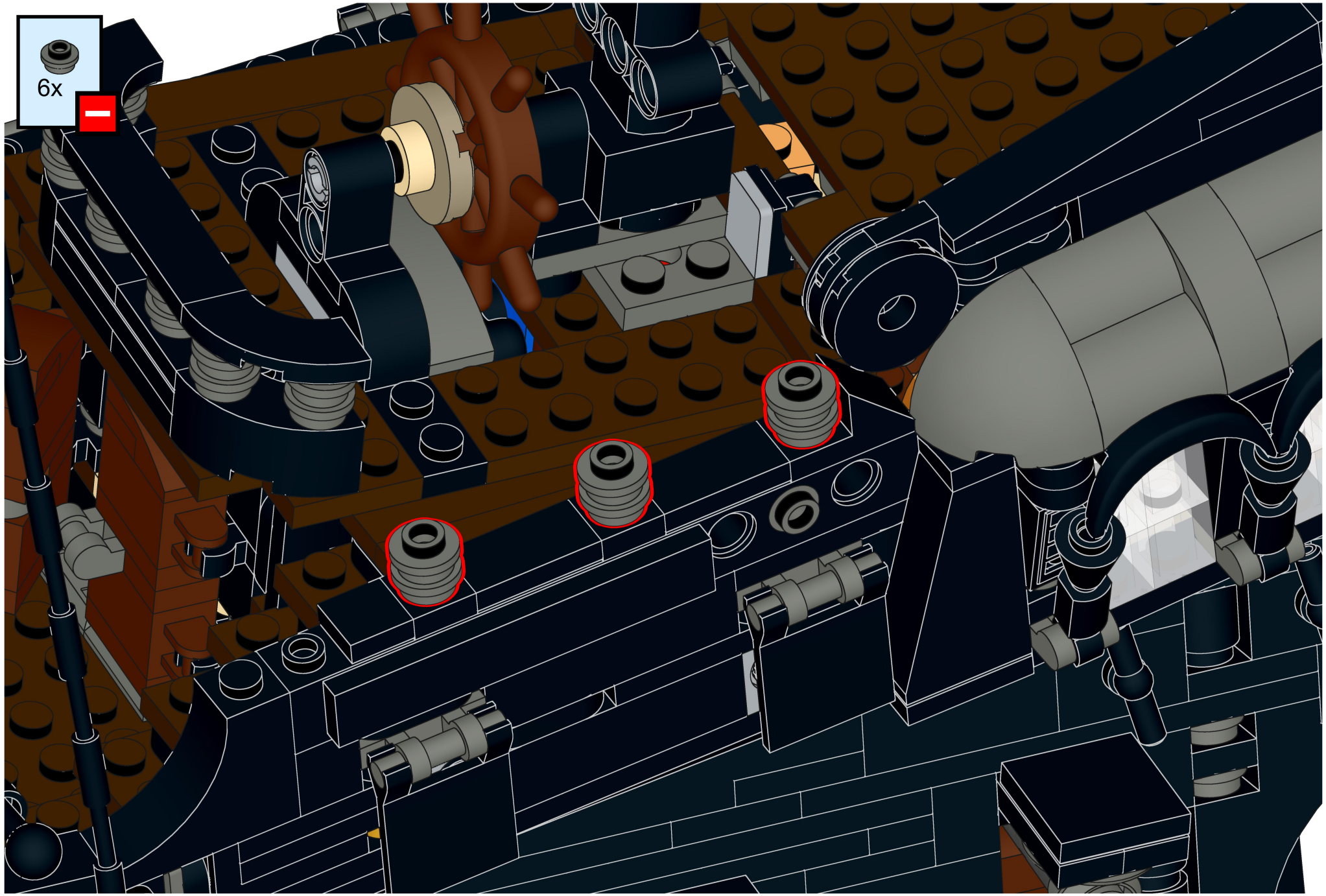

6x



1x 2x 2x 1x

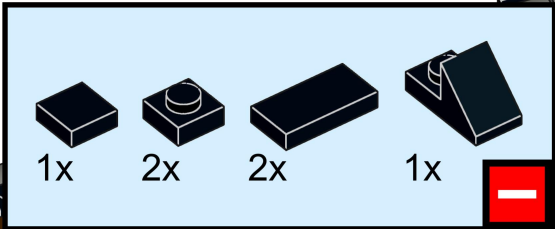

A parts list box containing four items: a 1x dark grey Technic brick, a 2x dark grey Technic brick with a hole, a 2x dark grey Technic brick, and a 1x dark grey Technic brick with a hole. A red minus sign icon is located to the right of the list.

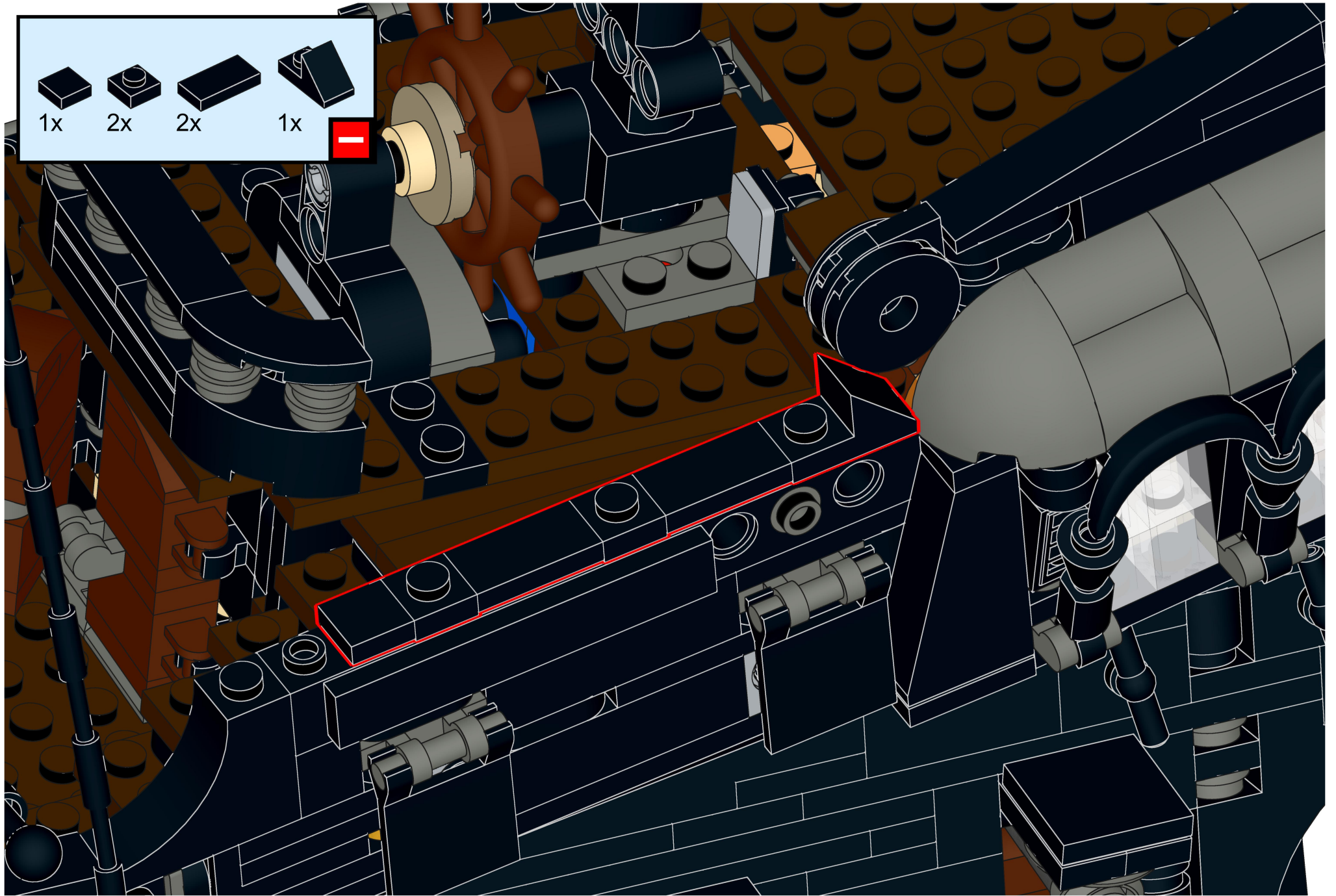

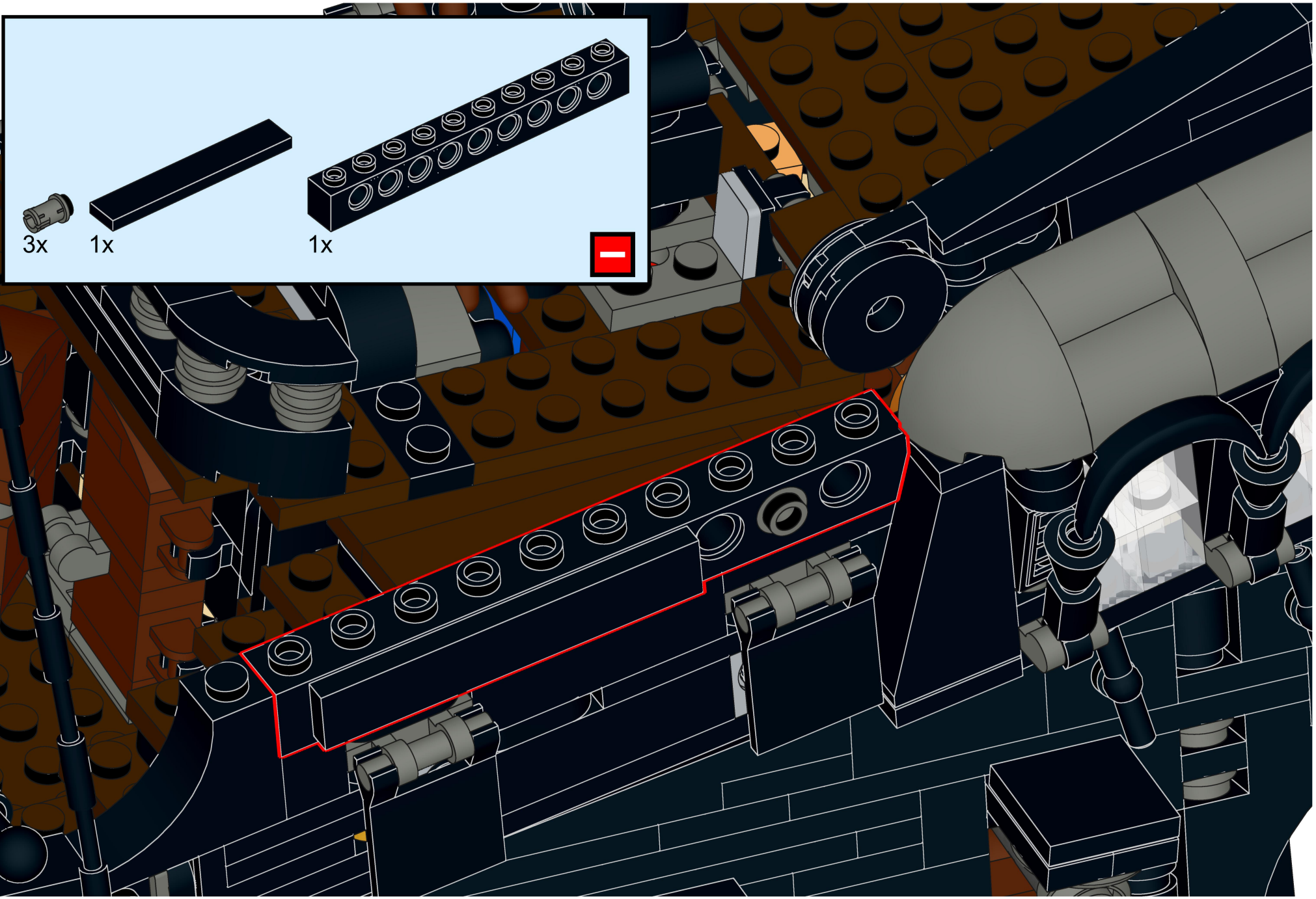

3x

1x

1x



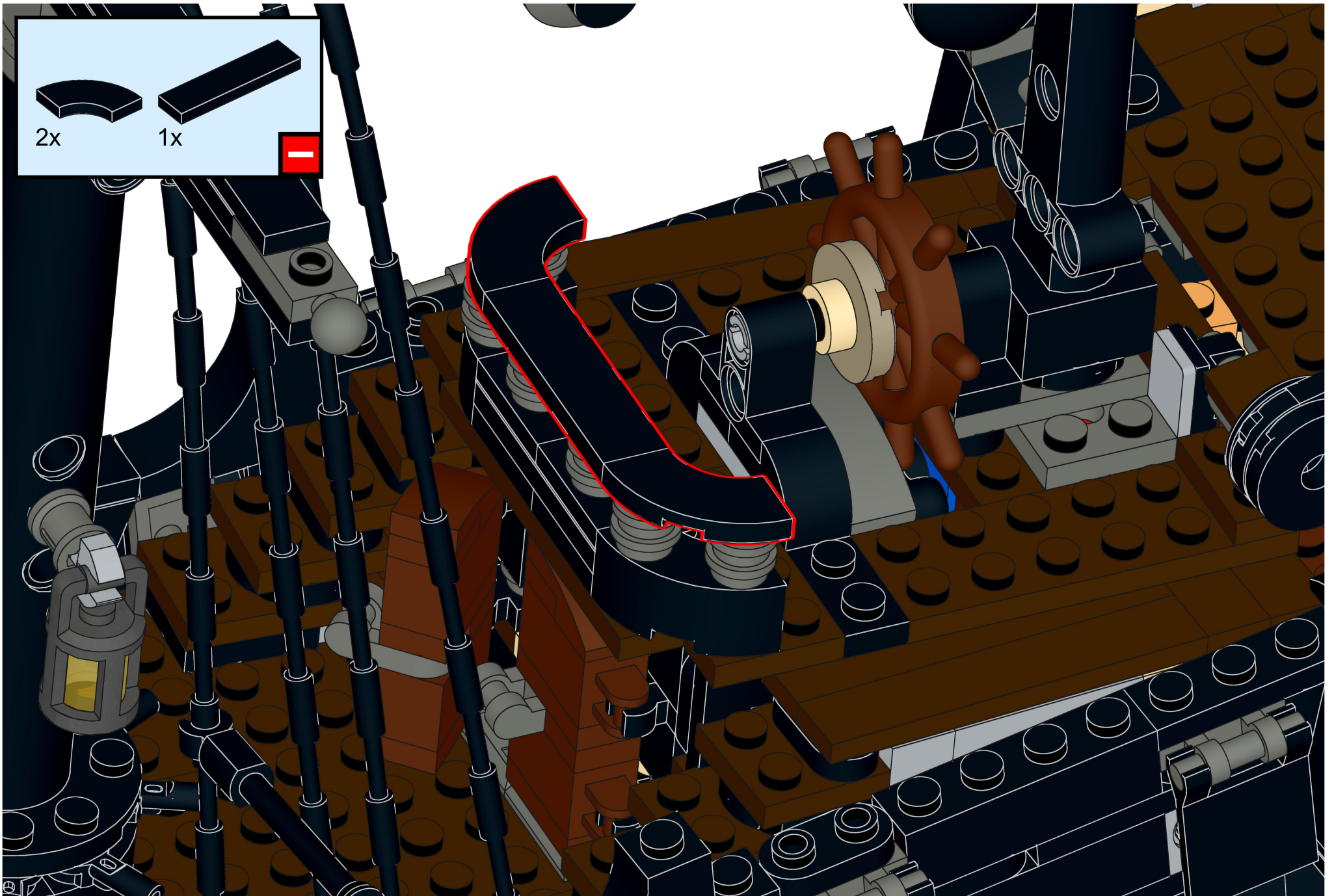

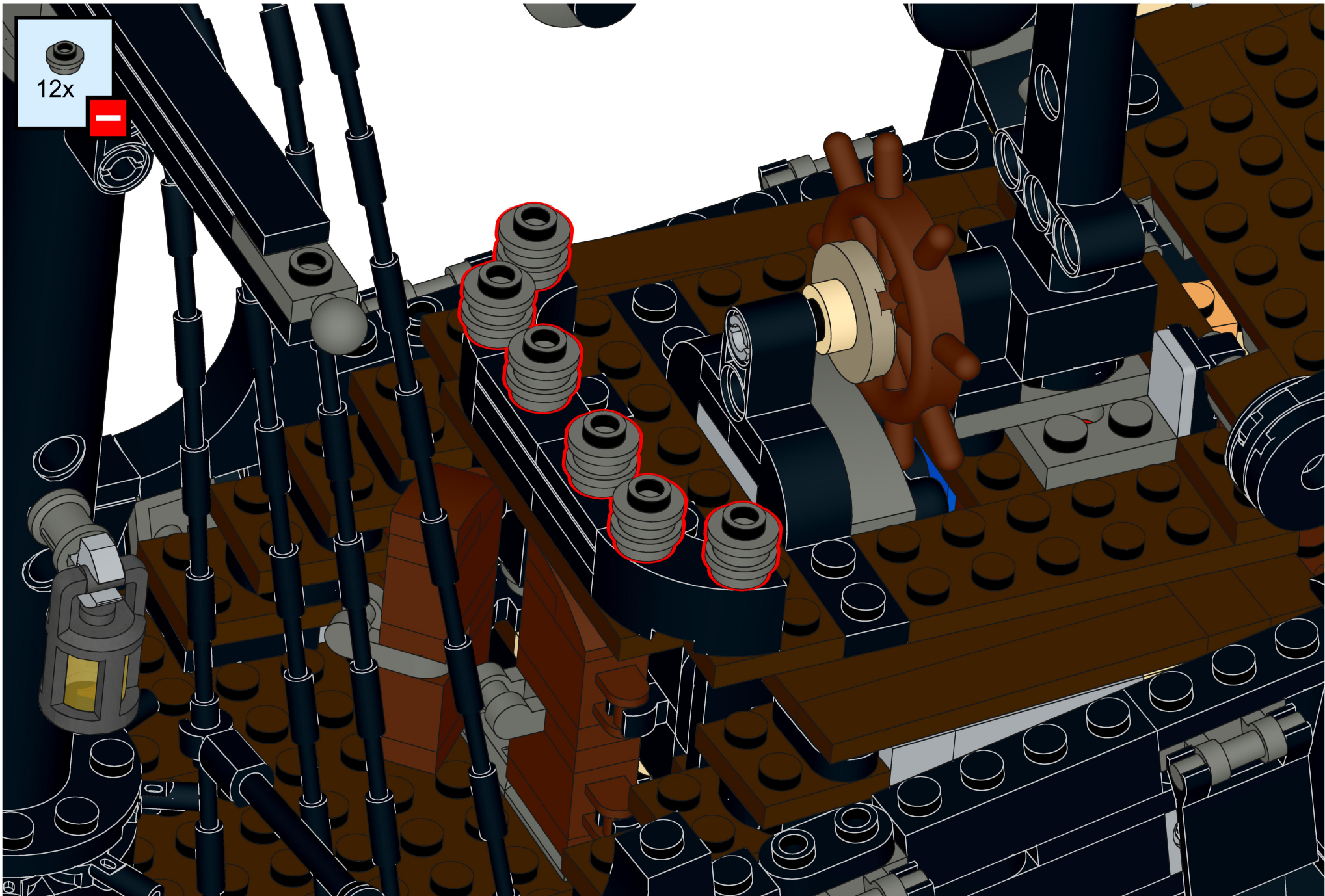

12x



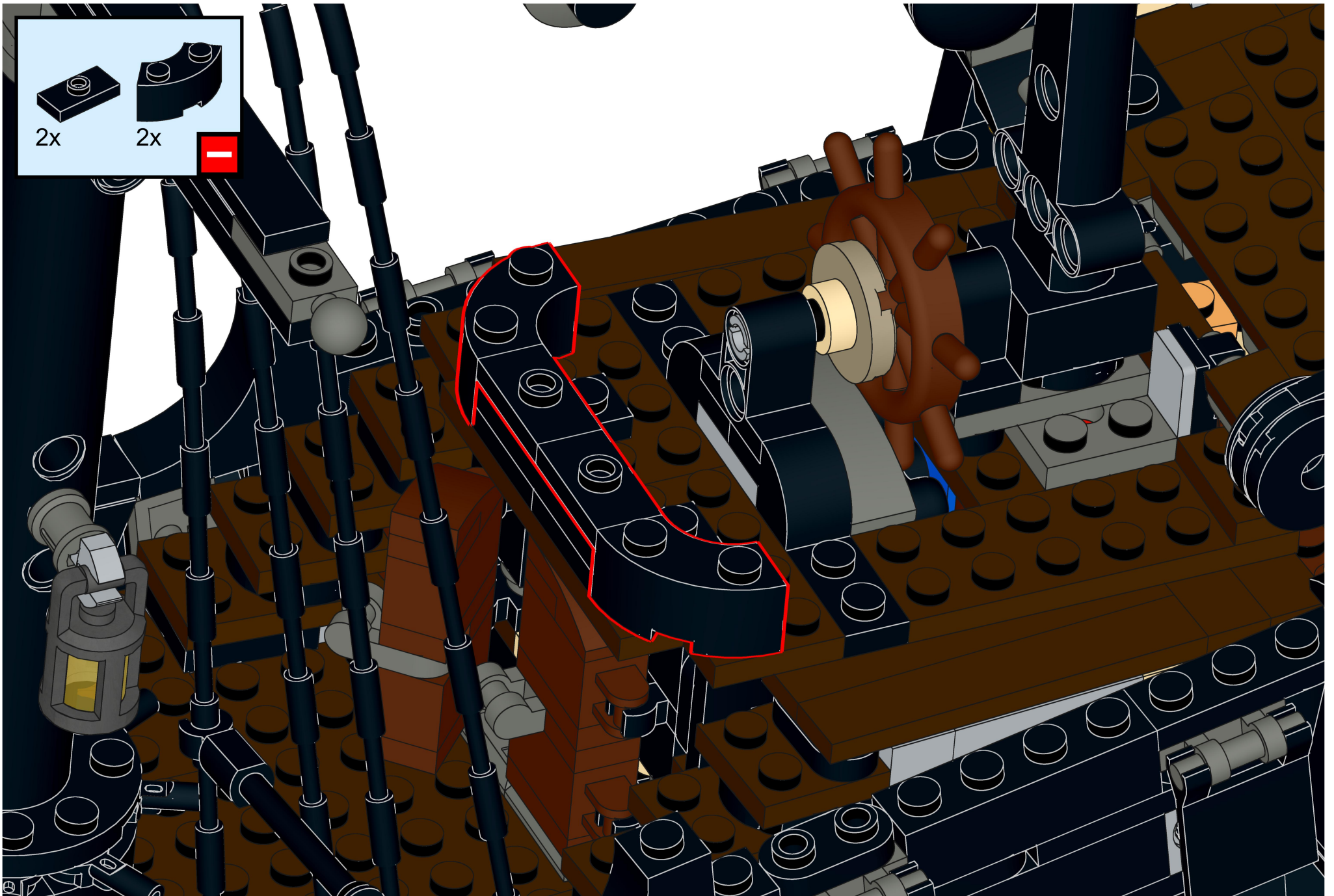

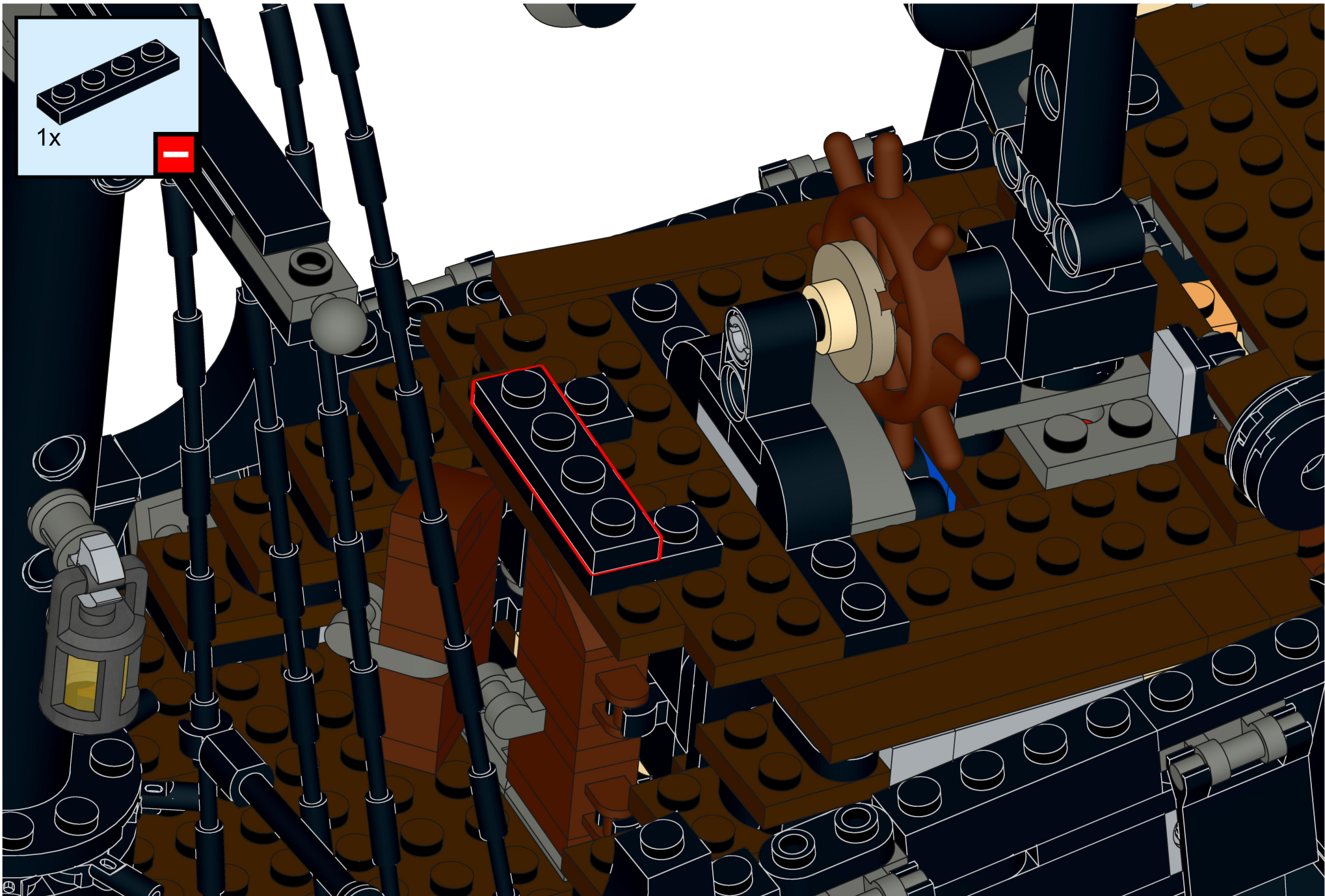







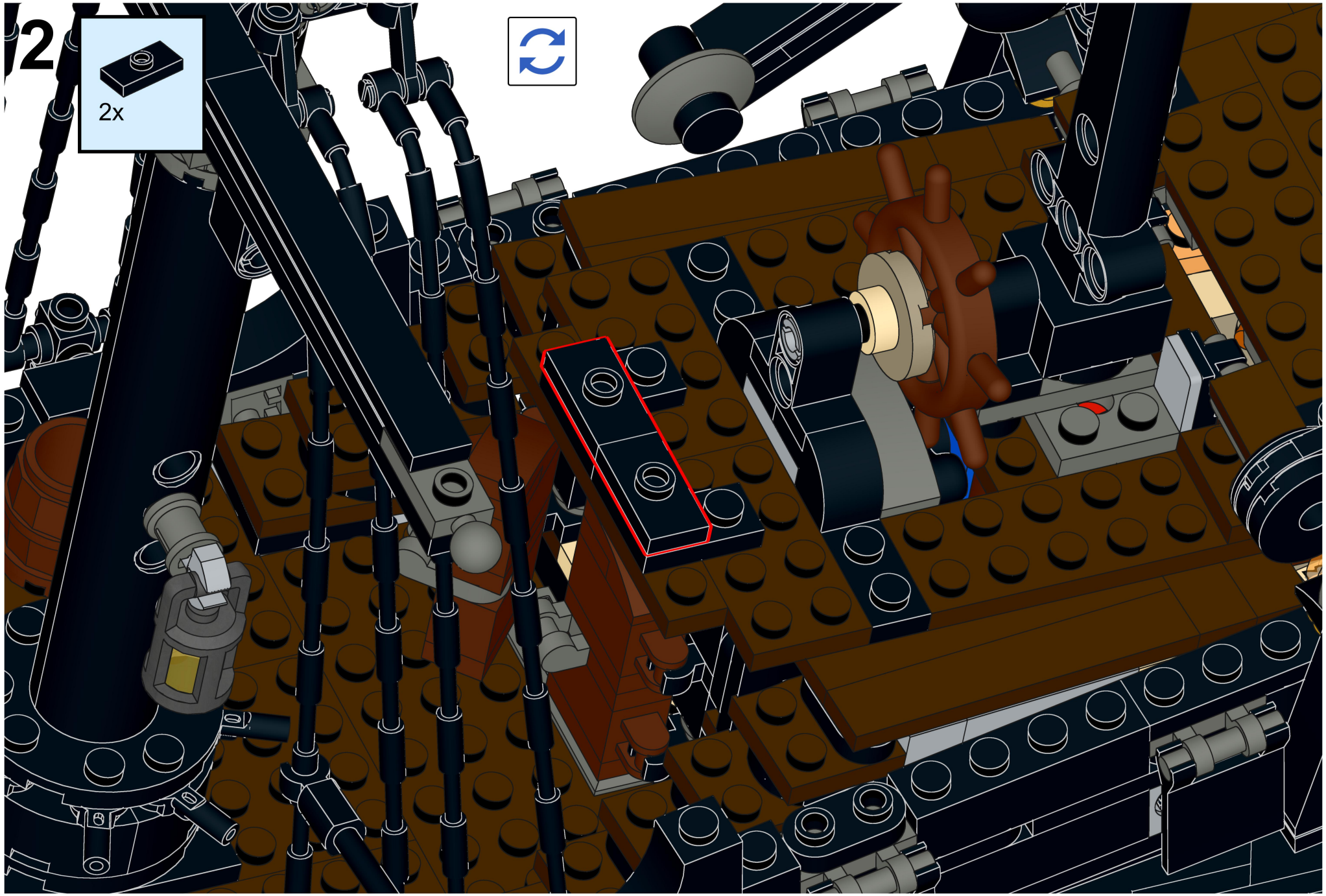

1/2

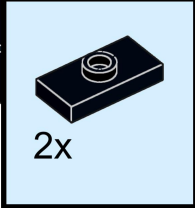

3

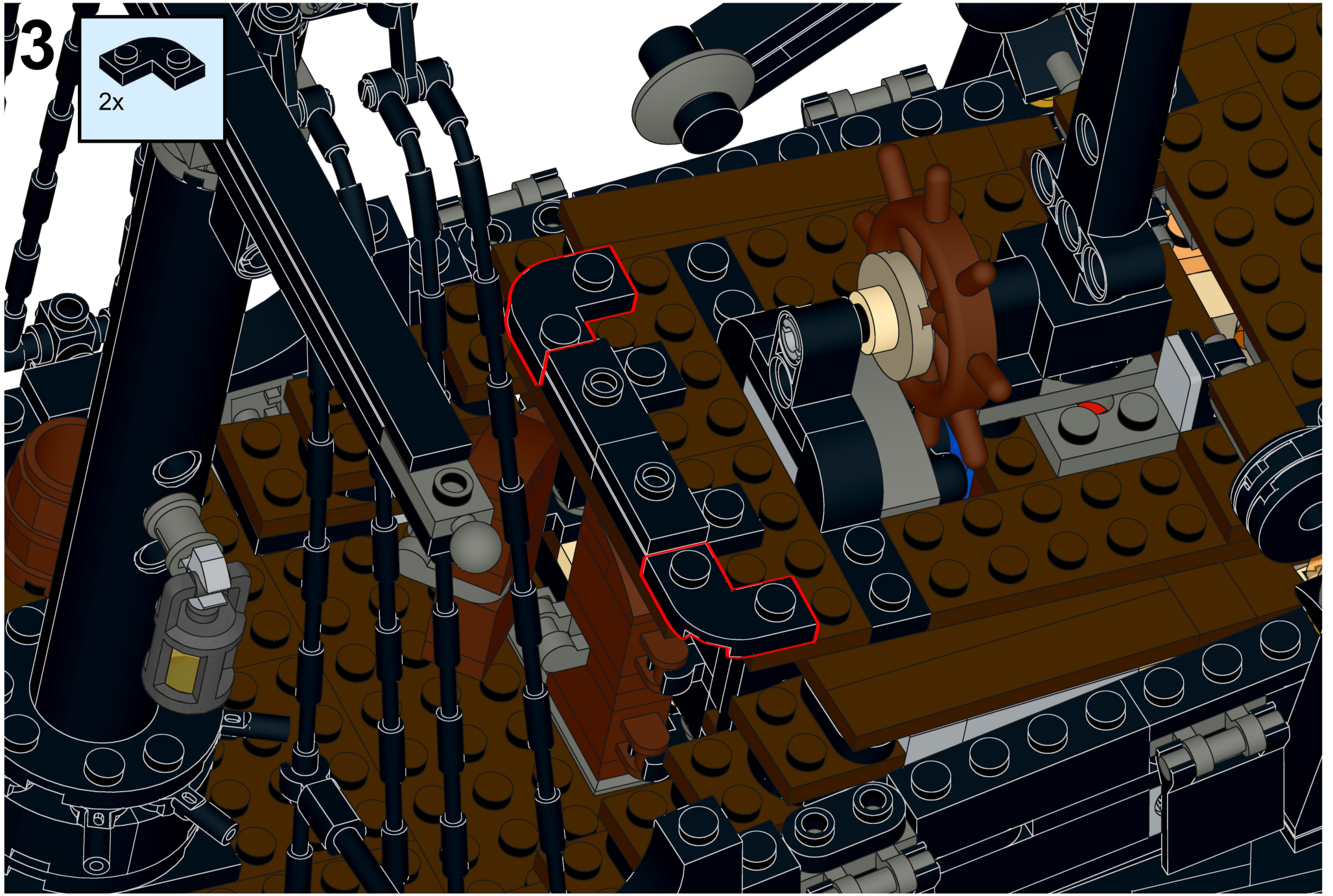

4

4x

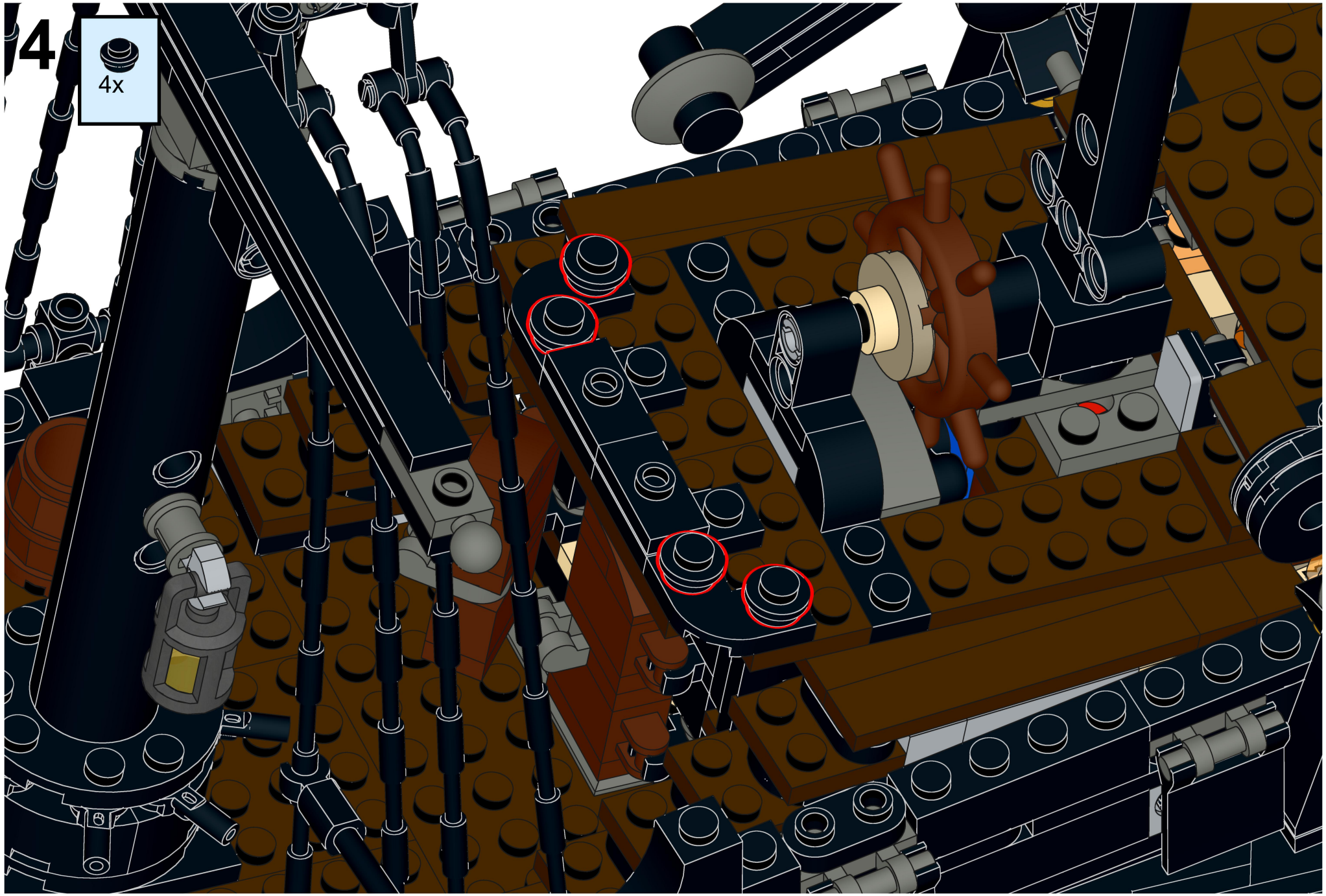

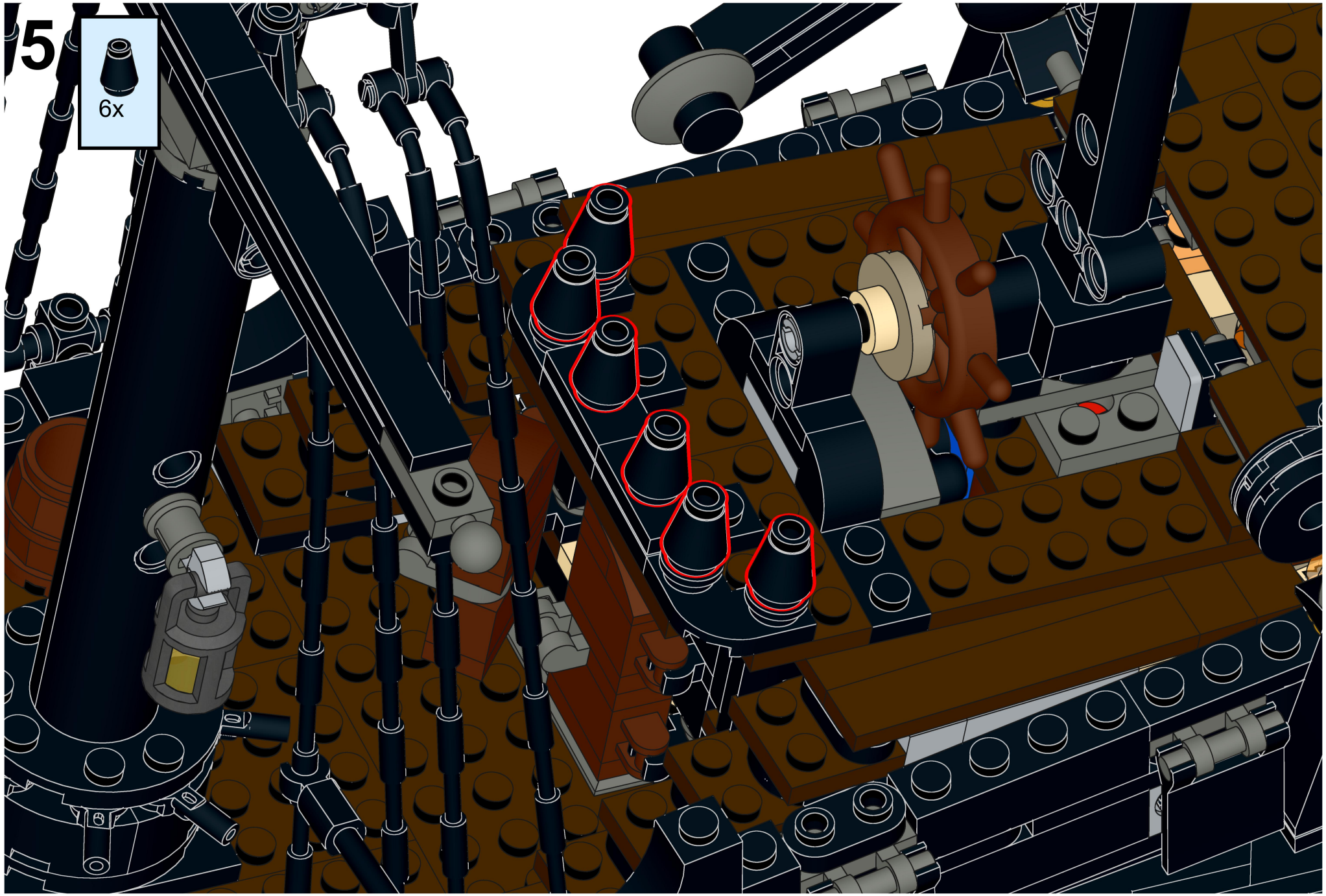

15

6x

6

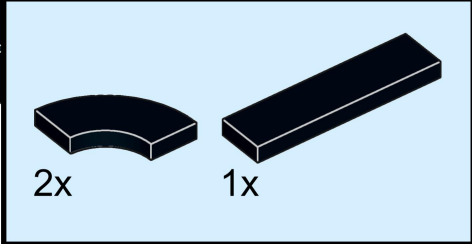

2x 1x

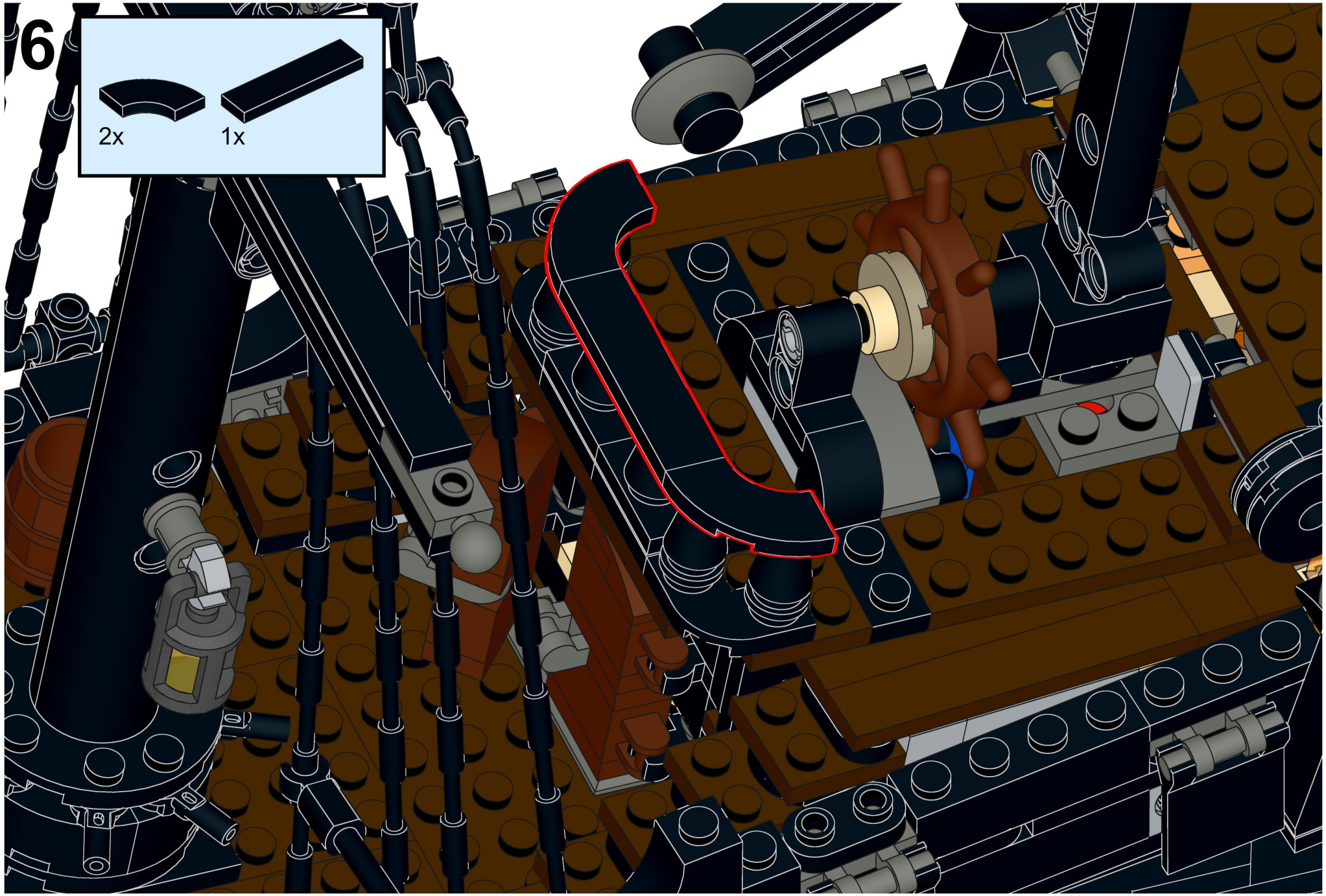

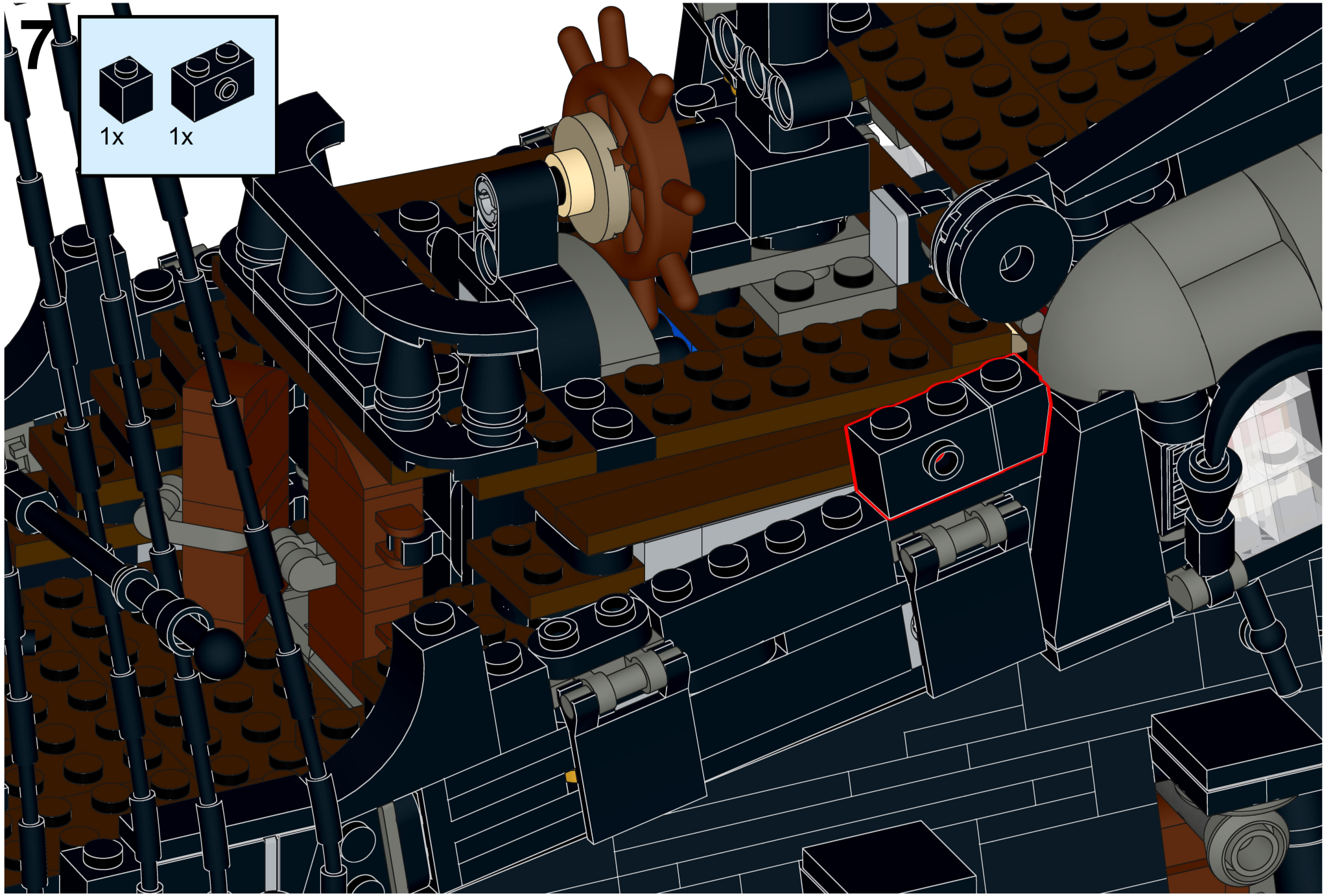

8

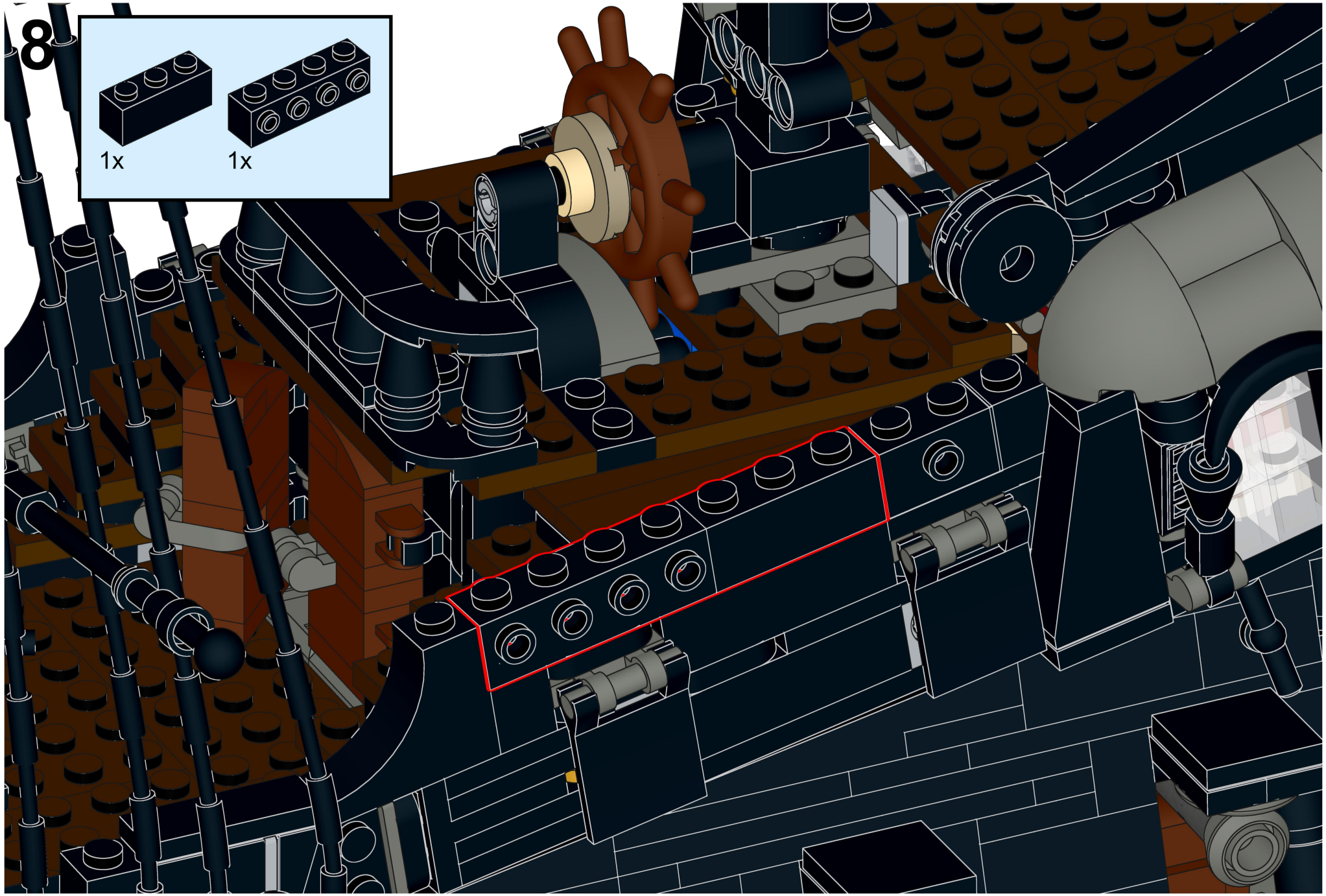
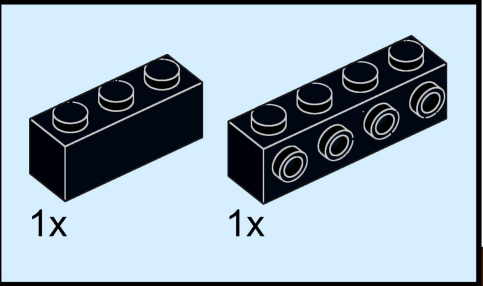

9

1x

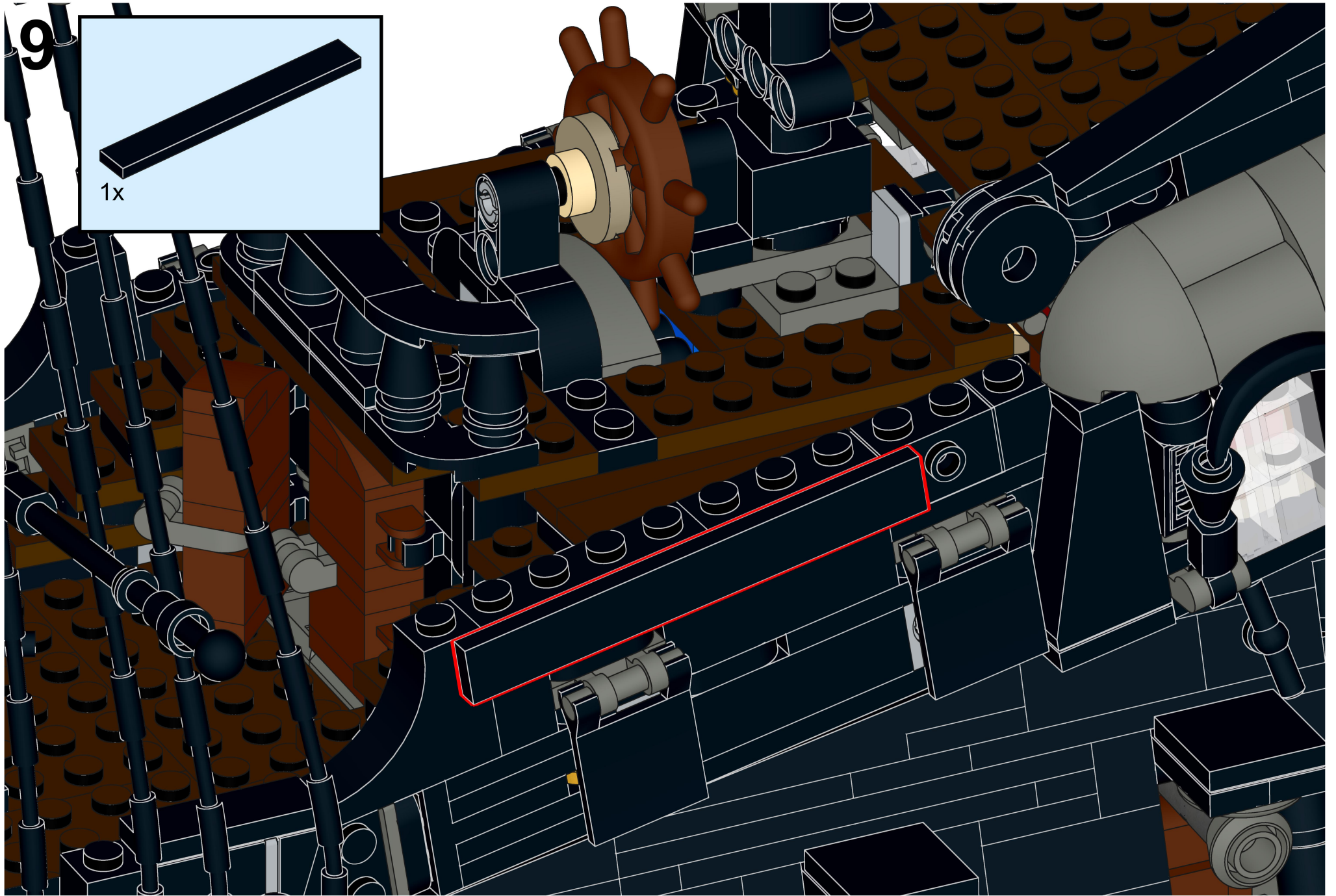

10

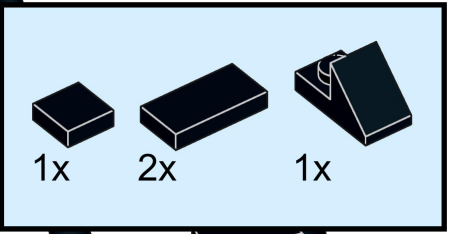

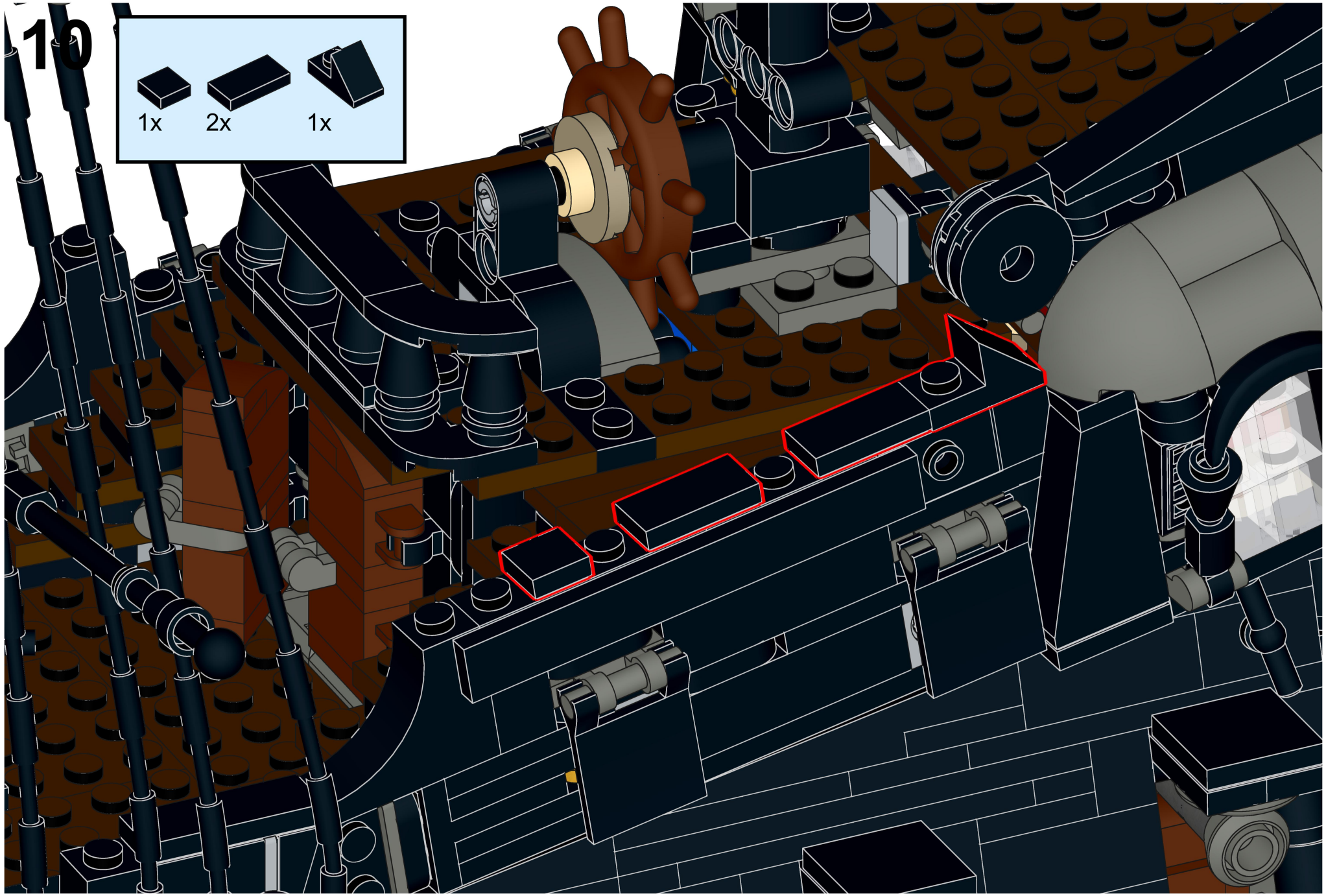

1x 2x 1x

This inset box shows the parts list for step 10. It contains three items: a 1x1 dark grey Technic brick, a 1x2 dark grey Technic brick, and a 1x2 dark grey Technic brick with a hole. Each item is accompanied by its quantity: '1x', '2x', and '1x' respectively.

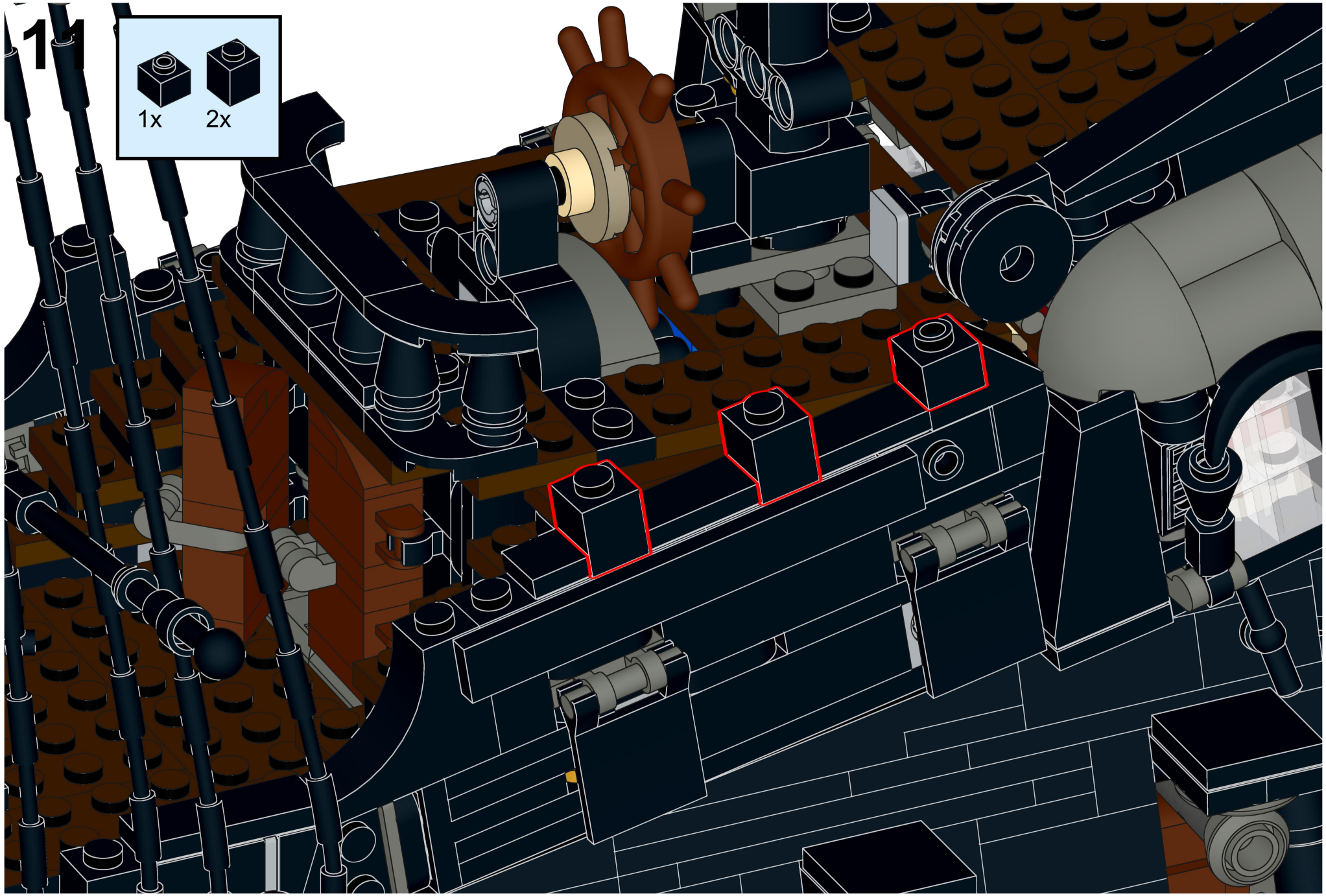



11

	
1x	2x

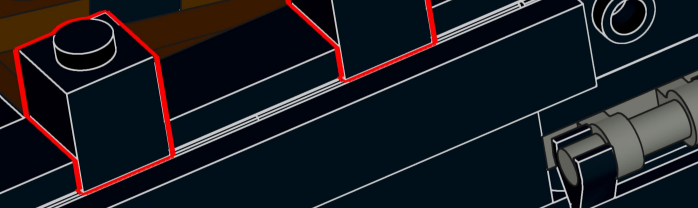

12

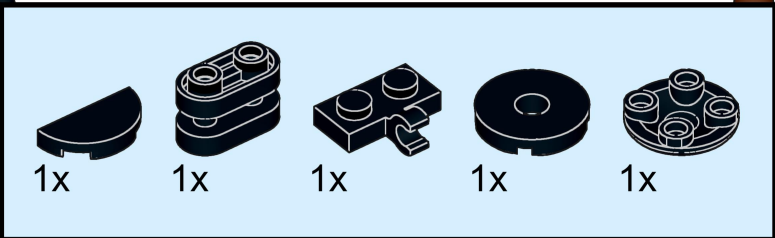

1x 1x 1x 1x 1x

This block contains a list of five LEGO parts, each with a '1x' quantity. From left to right: a dark grey 1/2 Technic plate; a dark grey 1x3 Technic axle connector; a dark grey 1x3 Technic axle connector with a hole; a dark grey 1x3 Technic axle connector with a hole and a raised edge; and a dark grey 1x3 Technic axle connector with three holes.

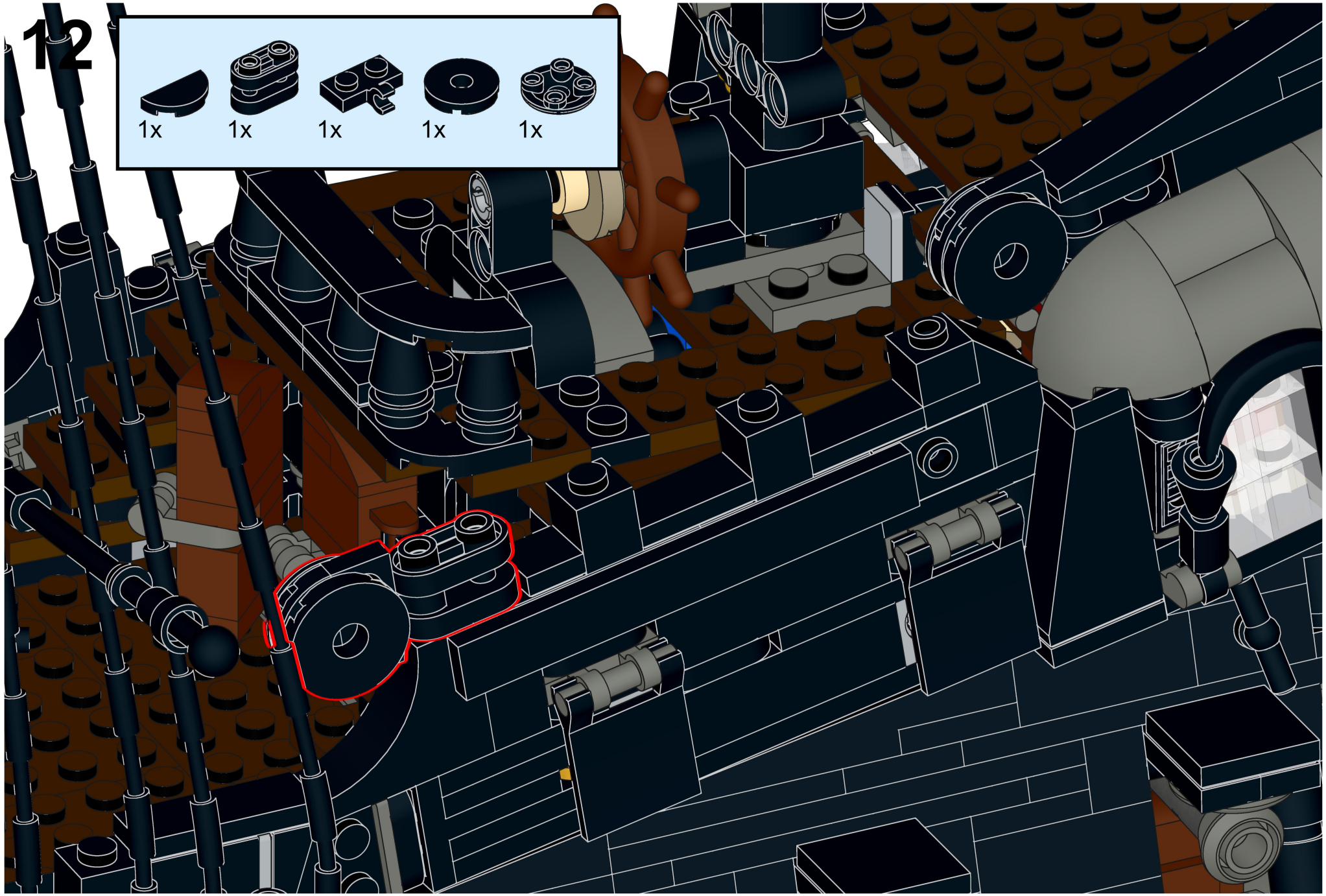

13

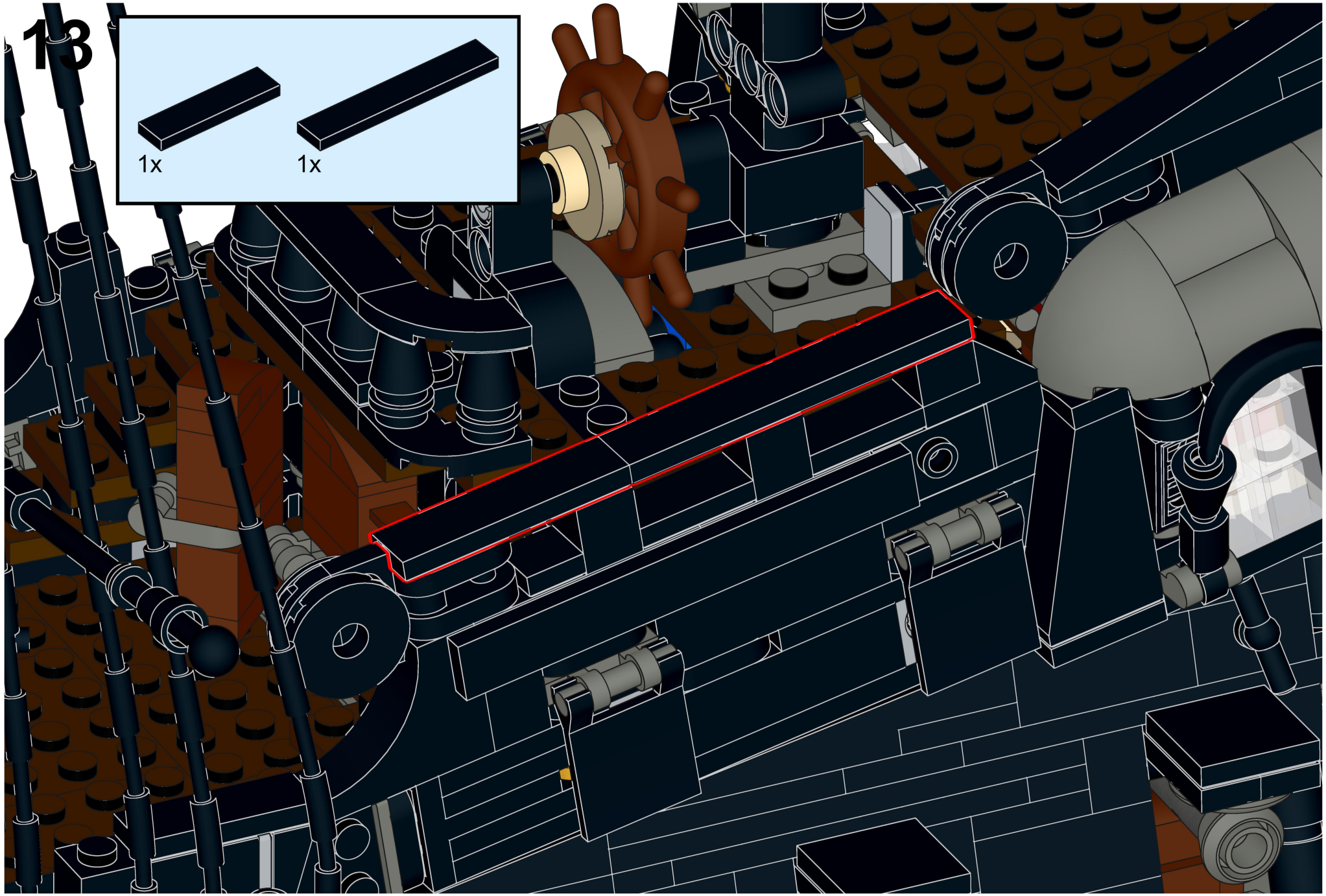
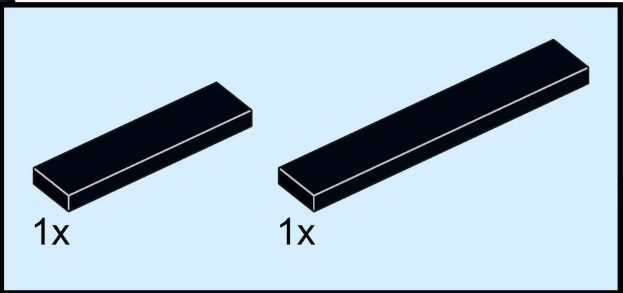

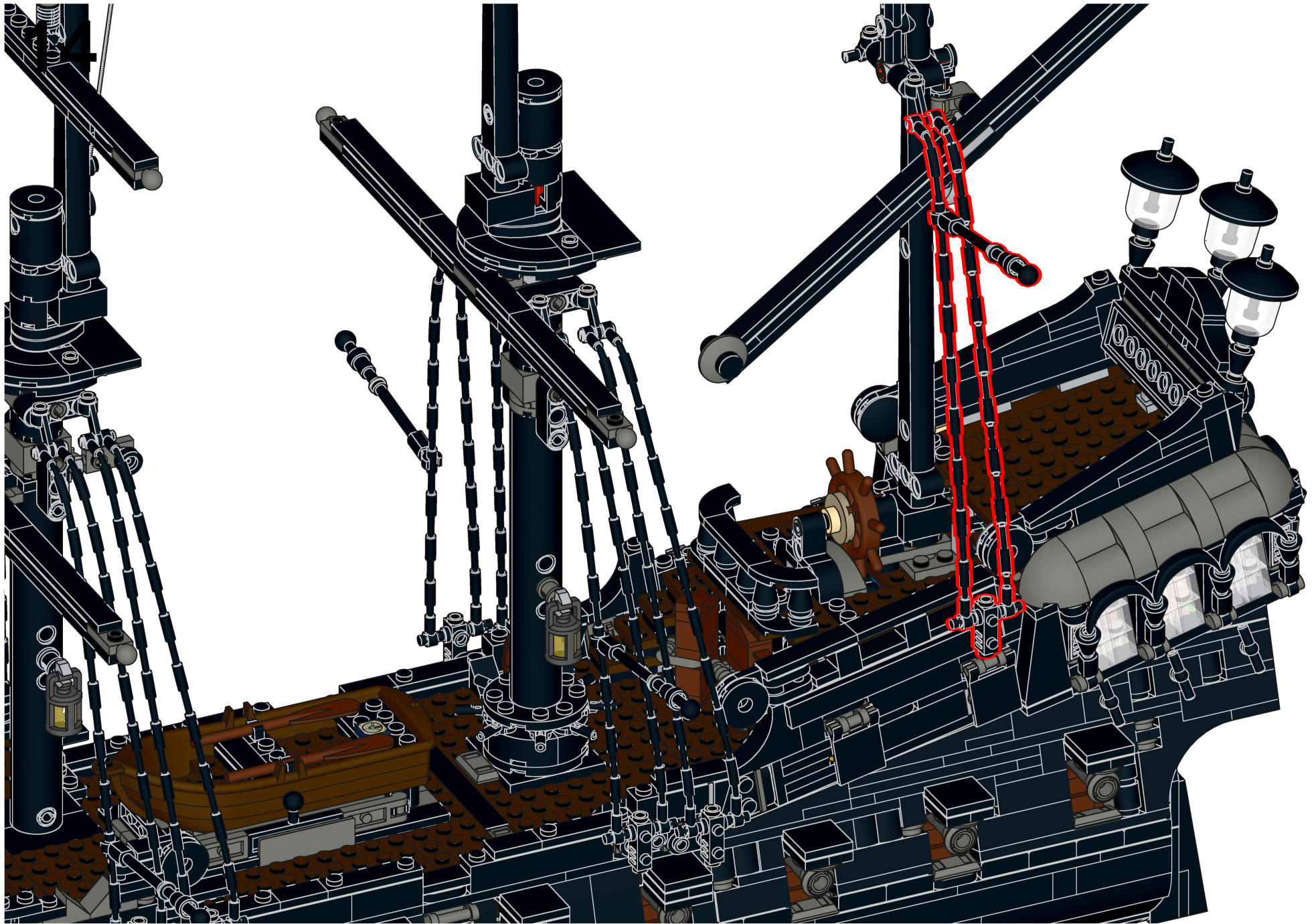

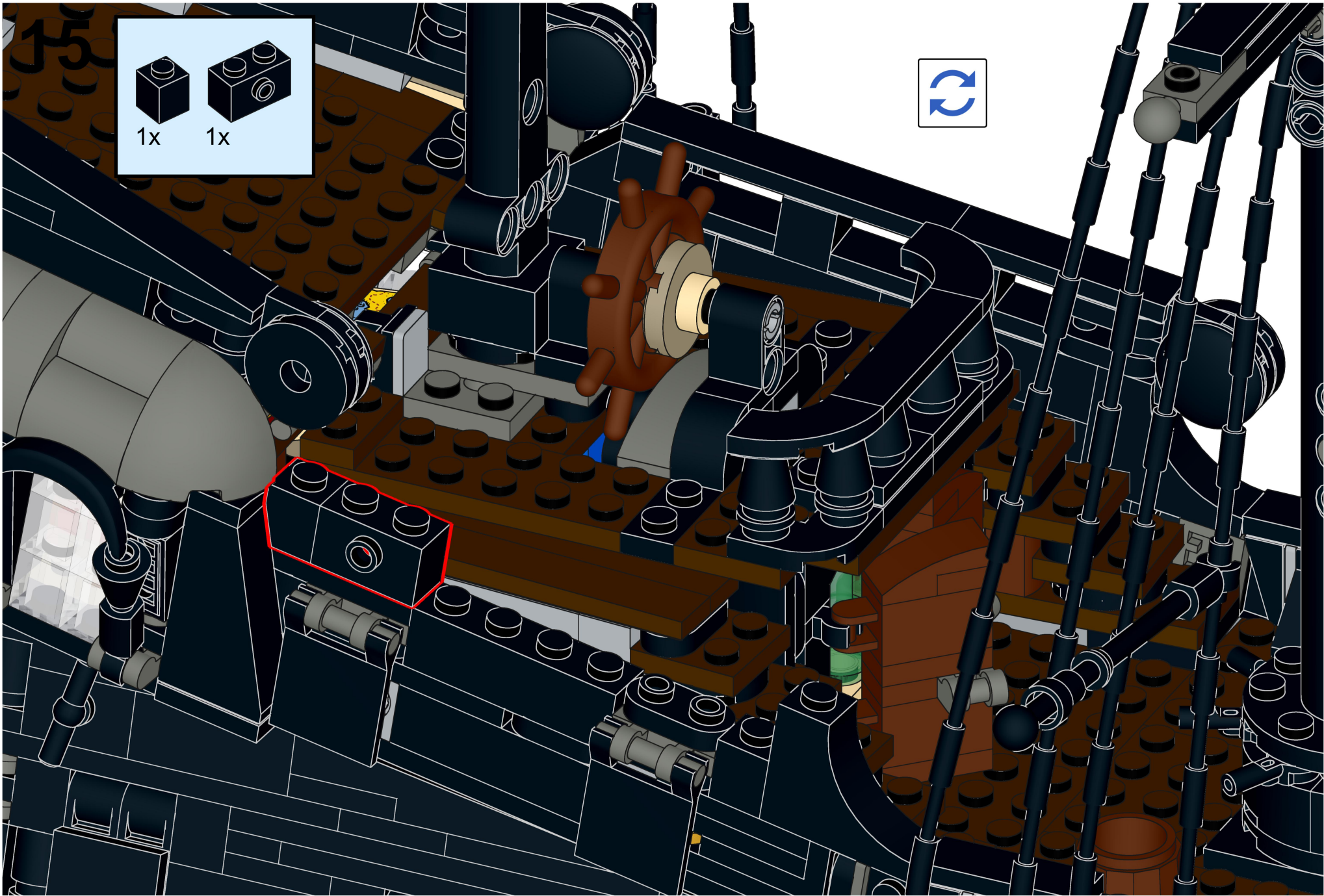
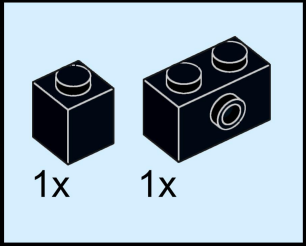

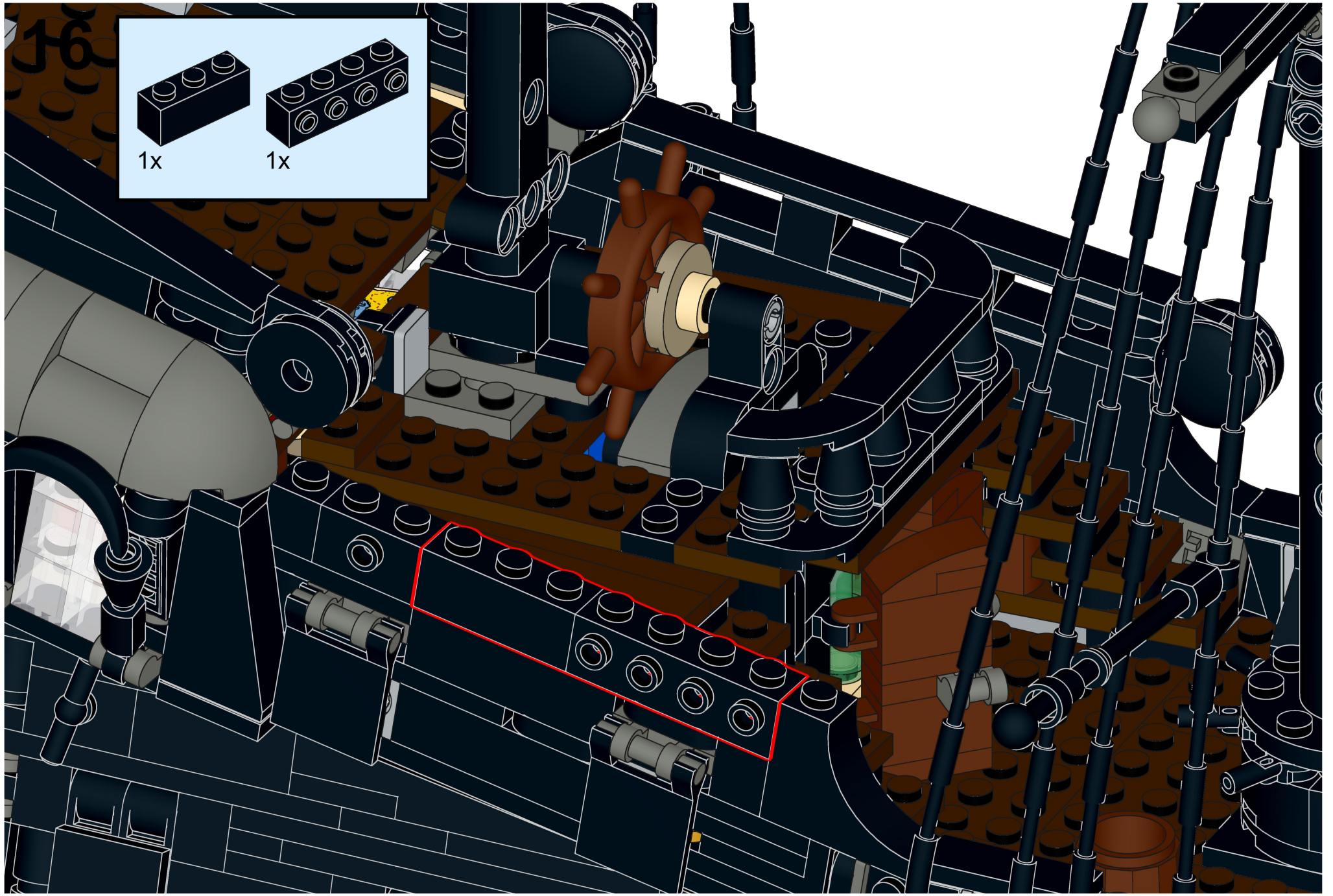

1x 1x

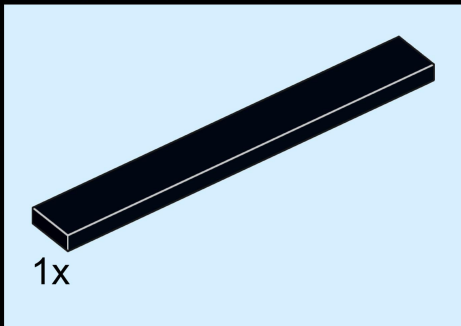
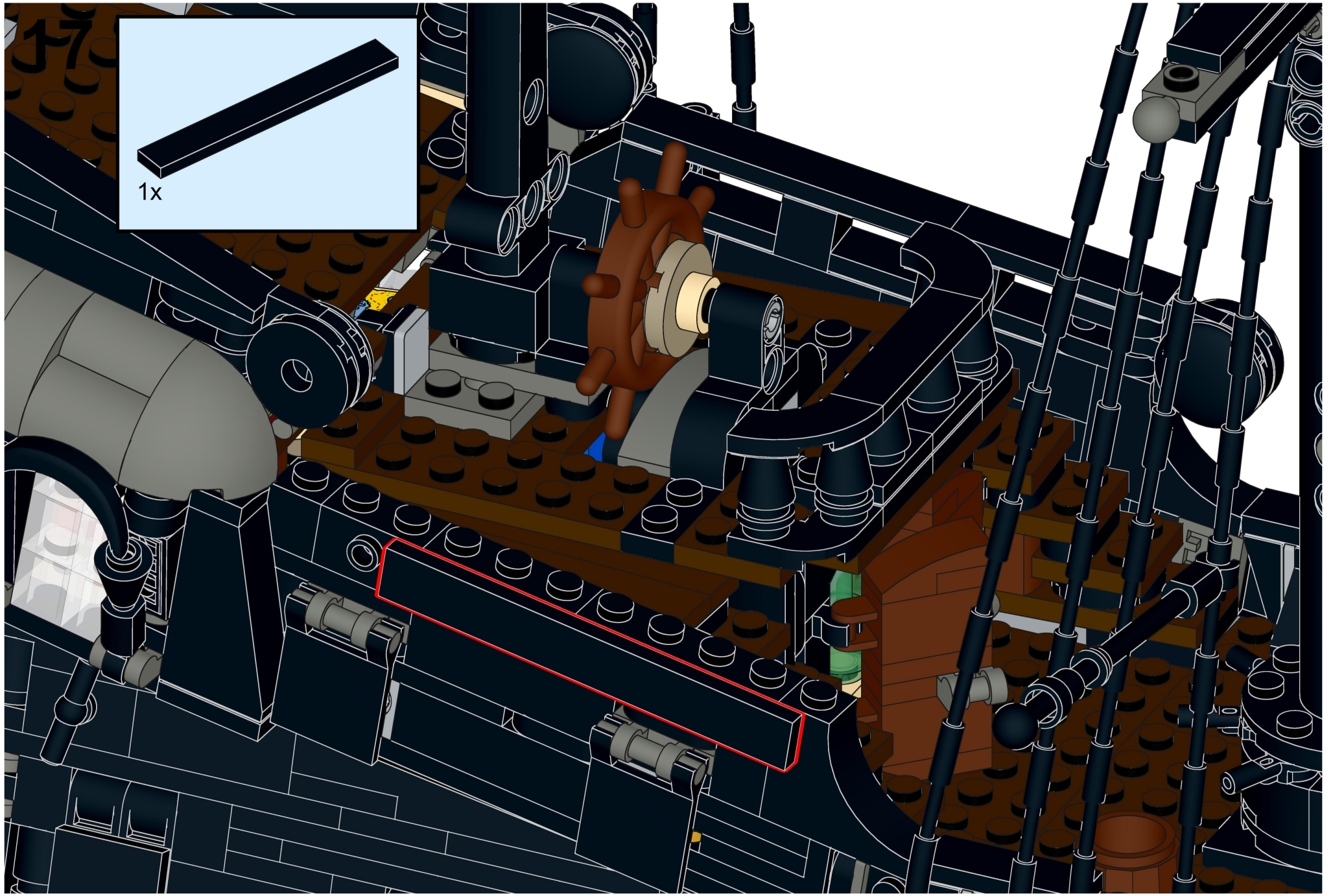

1x

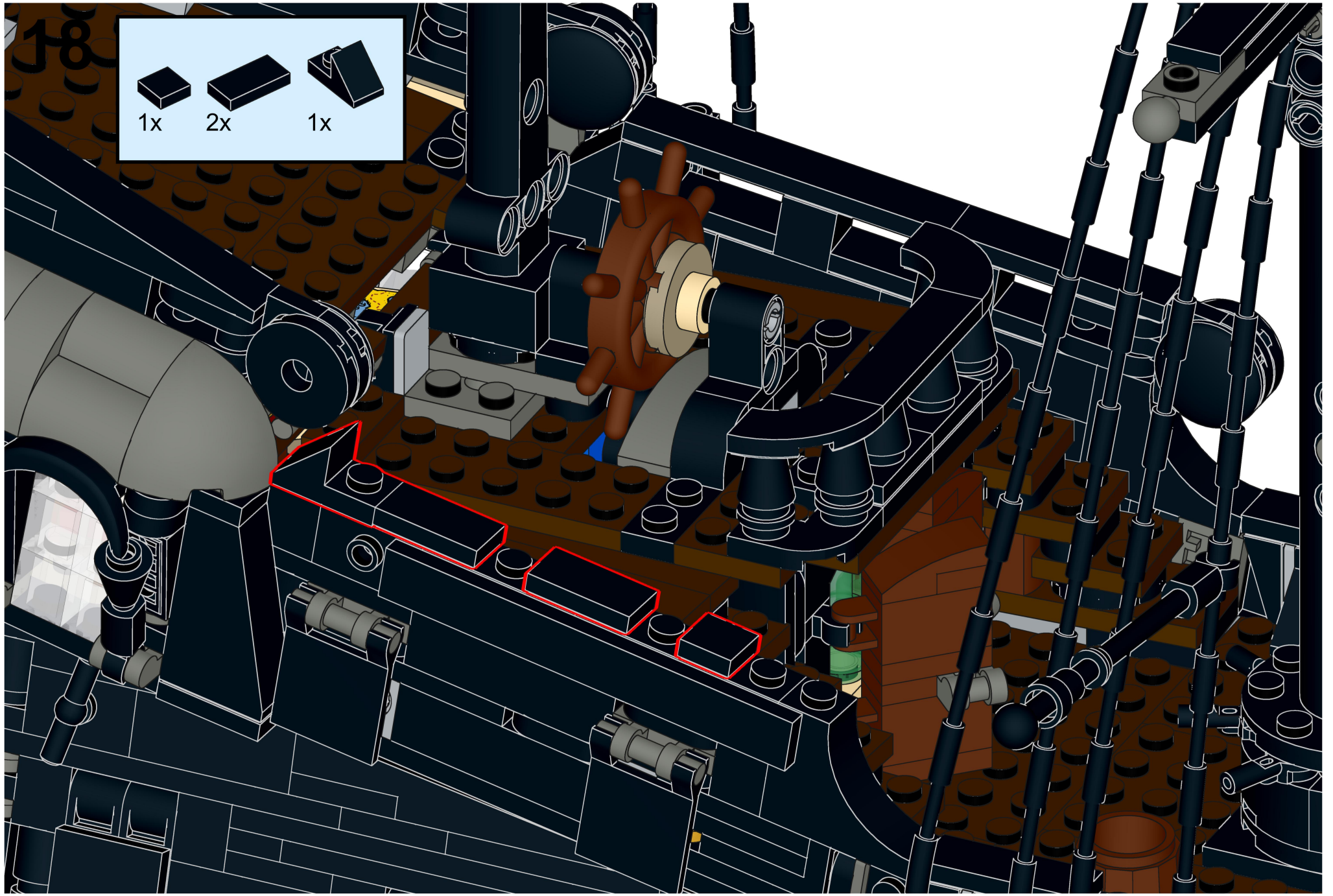

1x 2x 1x

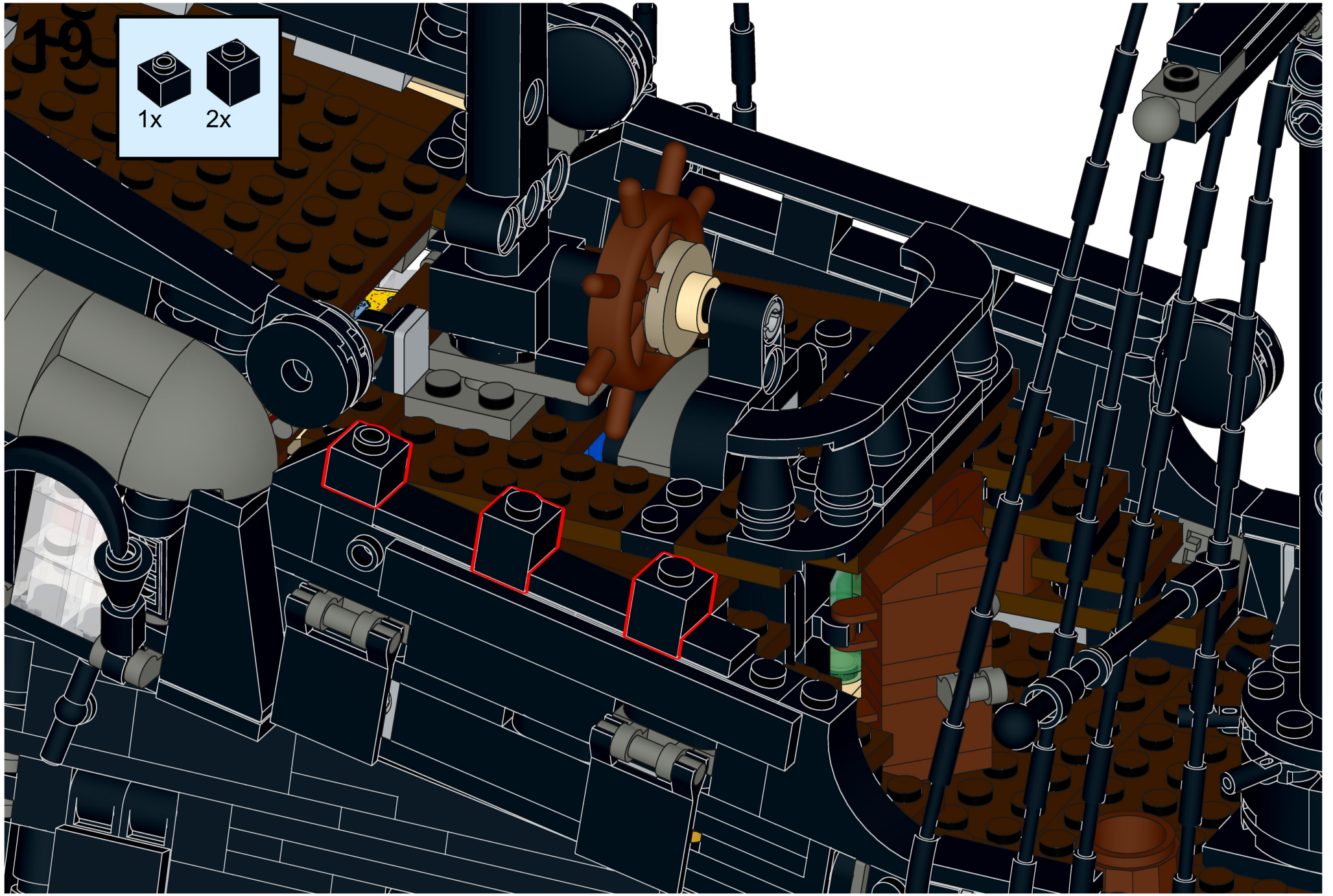

1x 2x

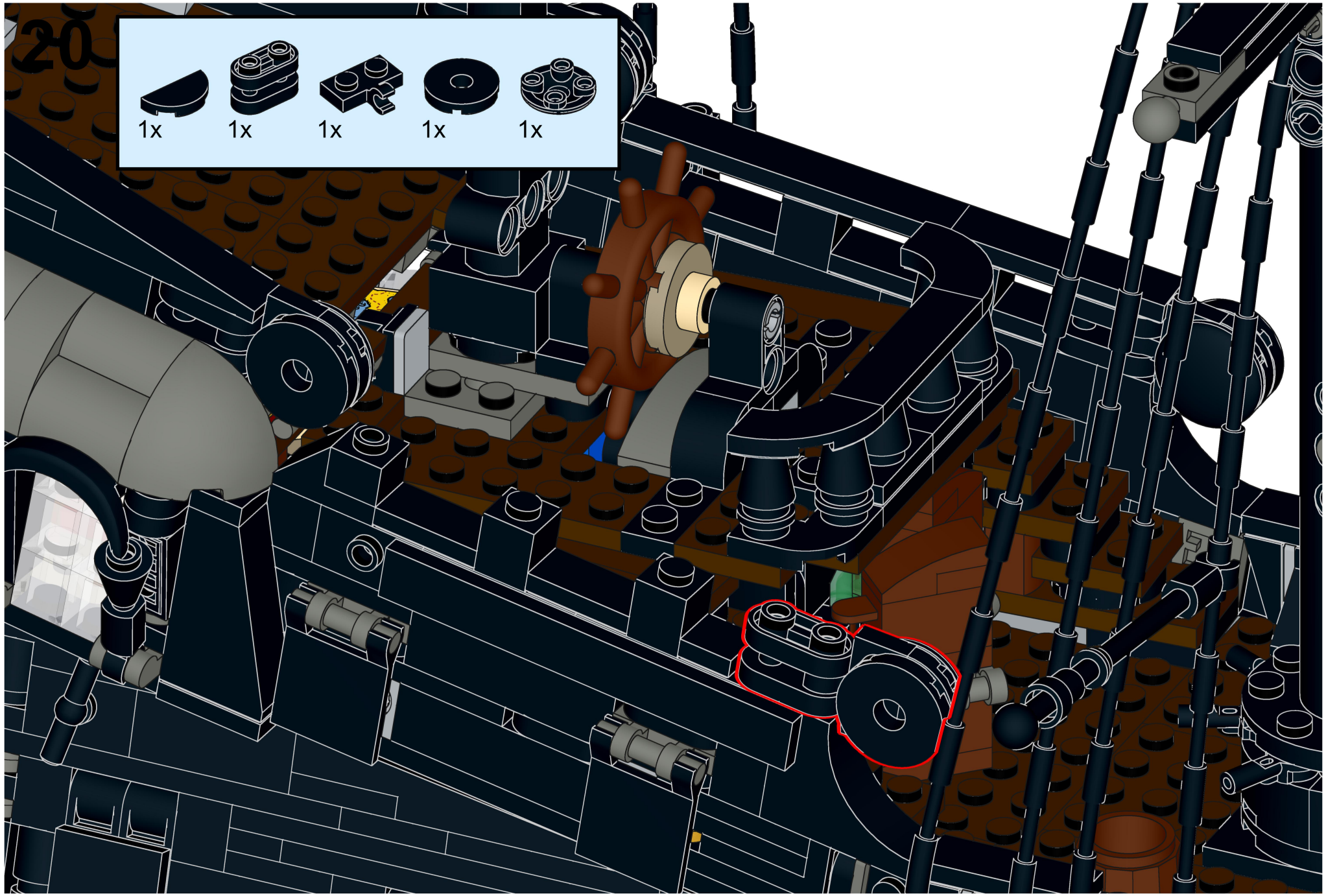

- 1x [Image of a dark grey 1/2 Technic wedge]
- 1x [Image of a dark grey 1x3 Technic axle with a hole]
- 1x [Image of a dark grey 1x3 Technic axle with a hole and a notch]
- 1x [Image of a dark grey 1x3 Technic axle with a hole]
- 1x [Image of a dark grey 1x3 Technic axle with a hole and a notch]

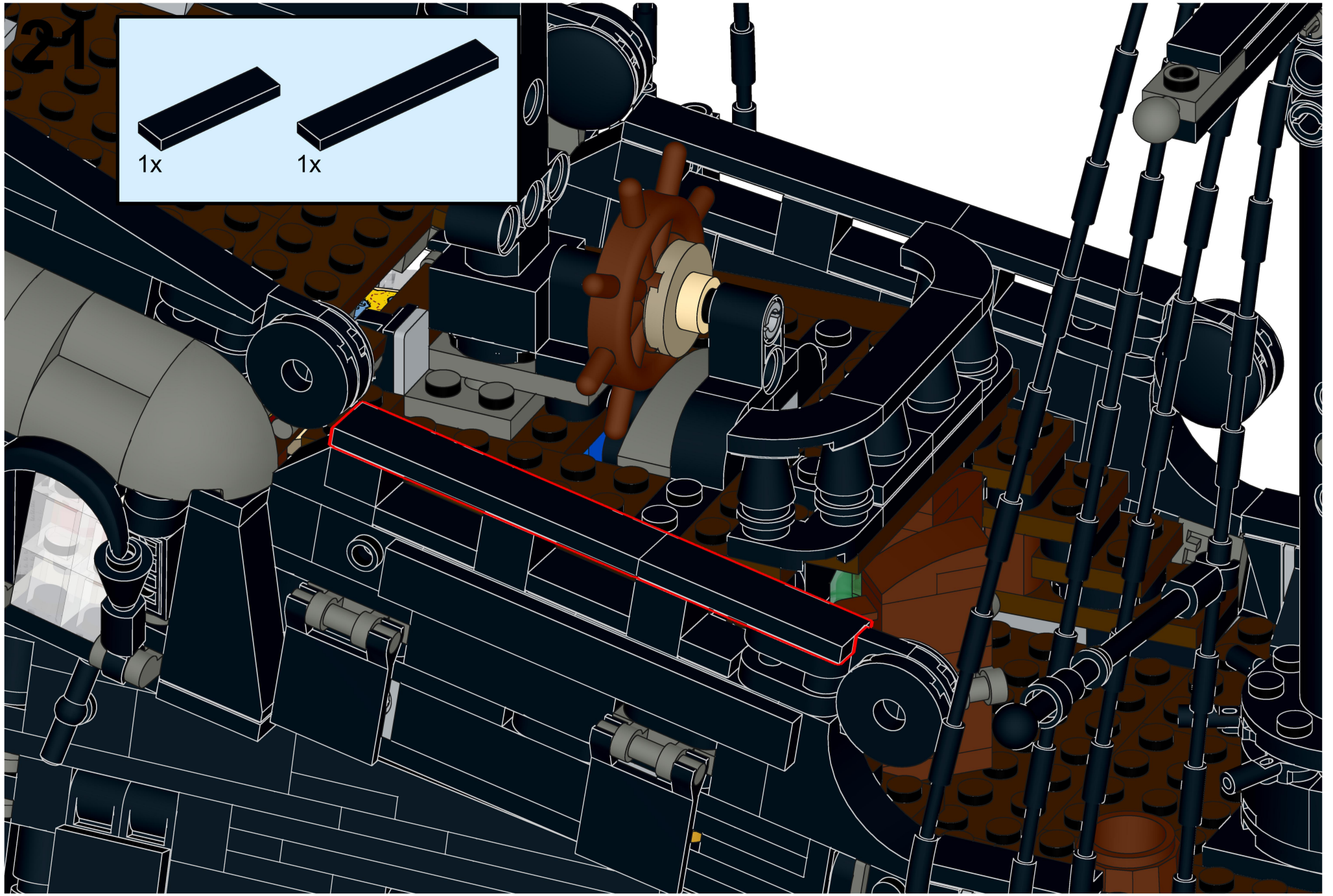

1x 1x

22

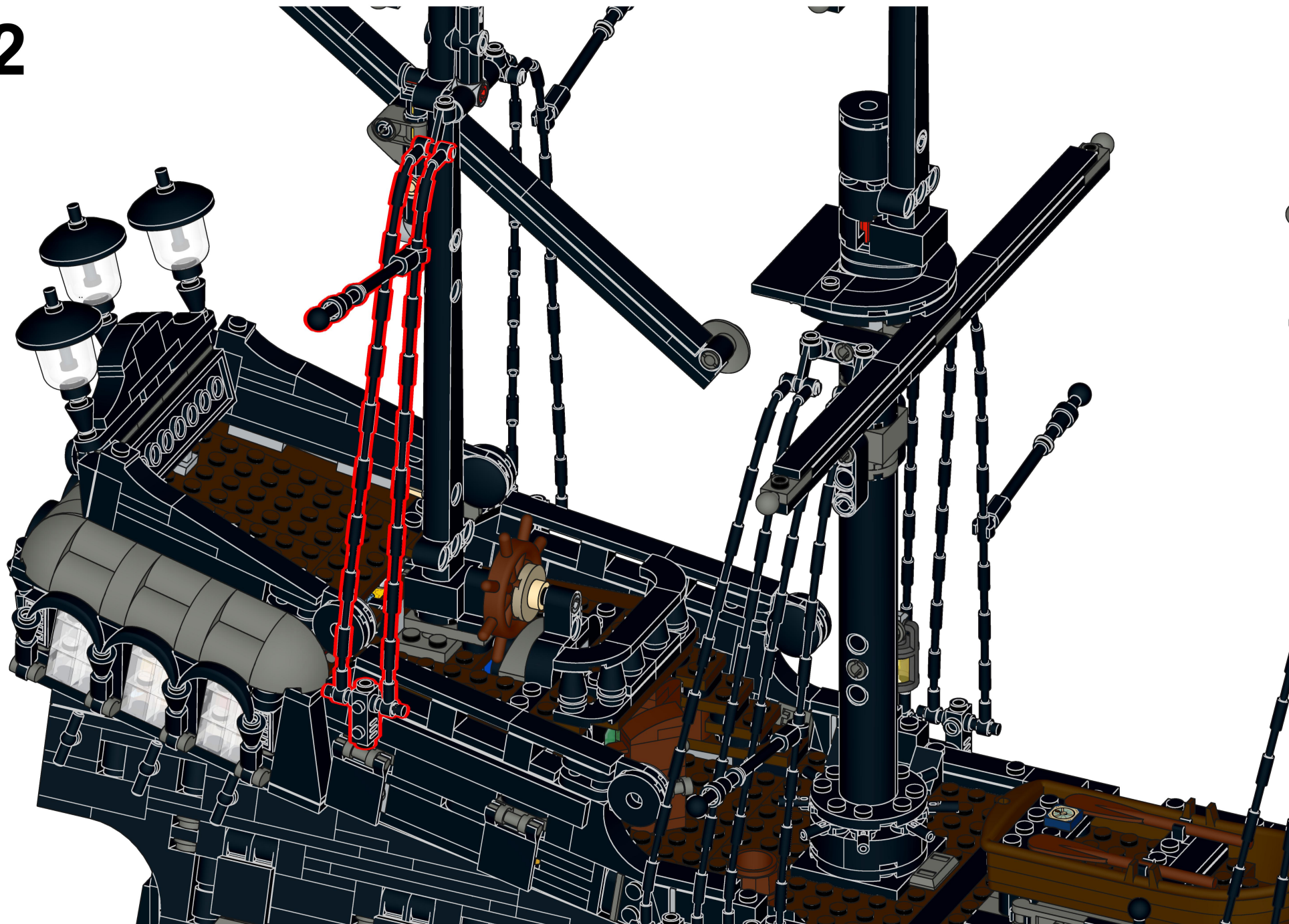

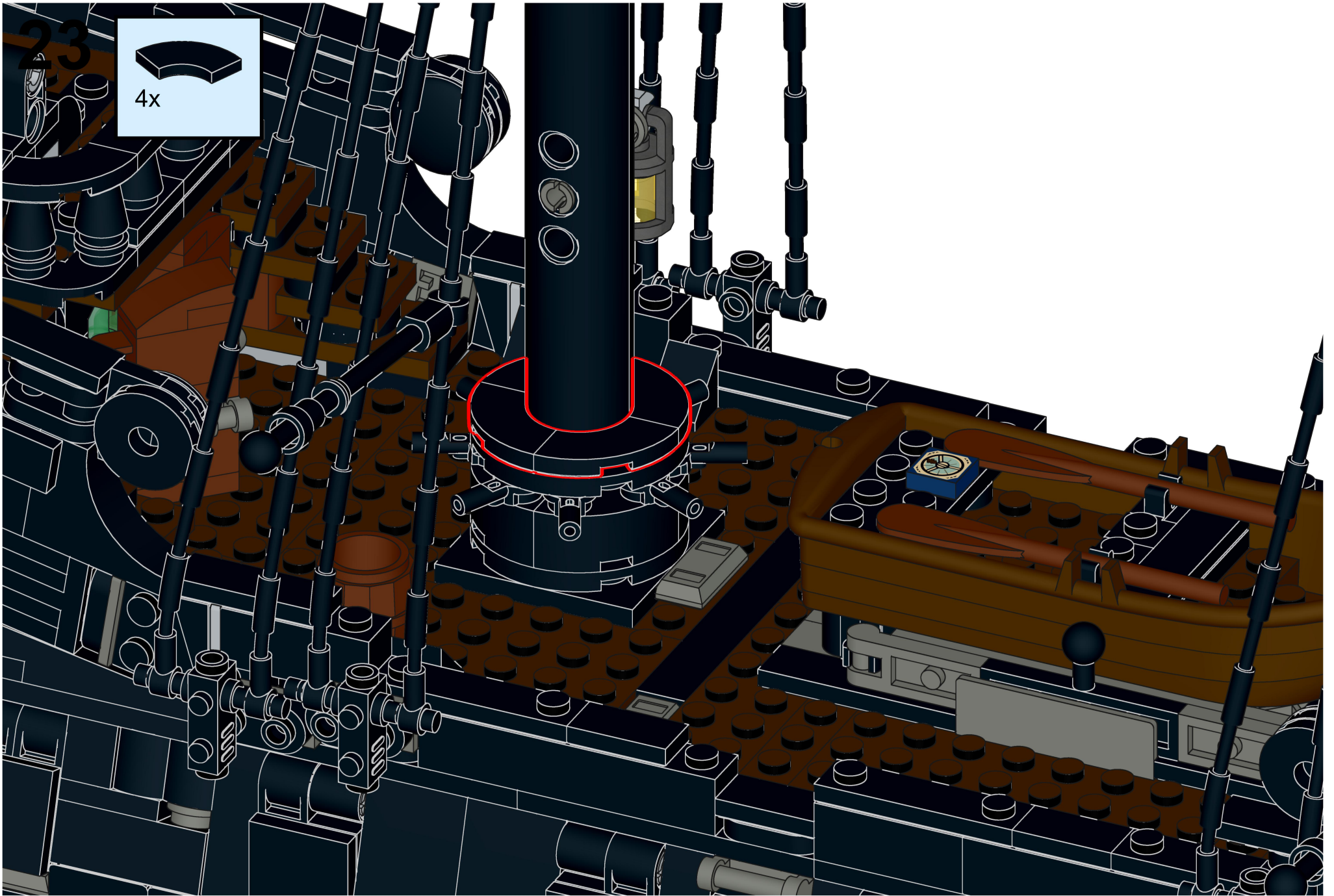

2x

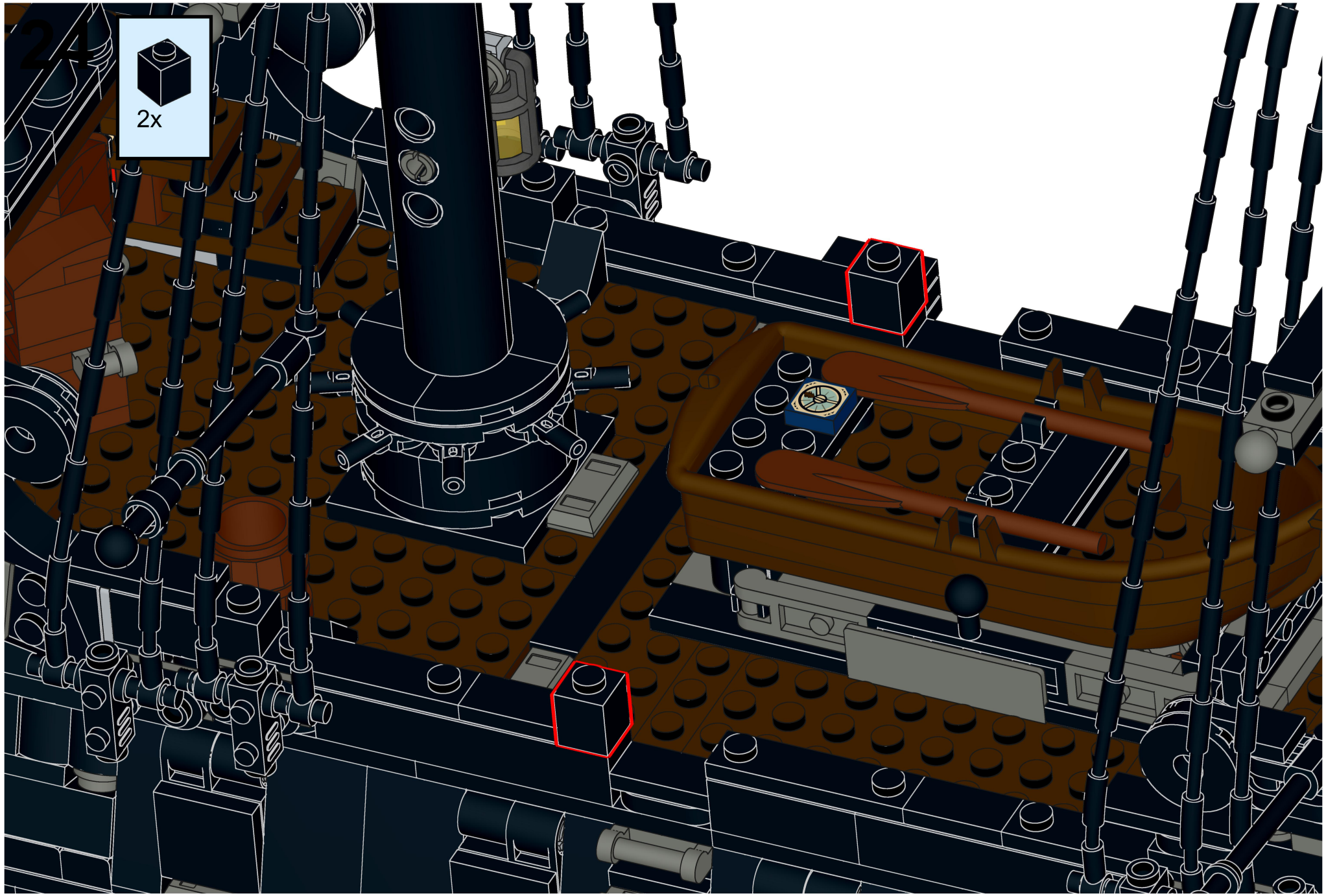

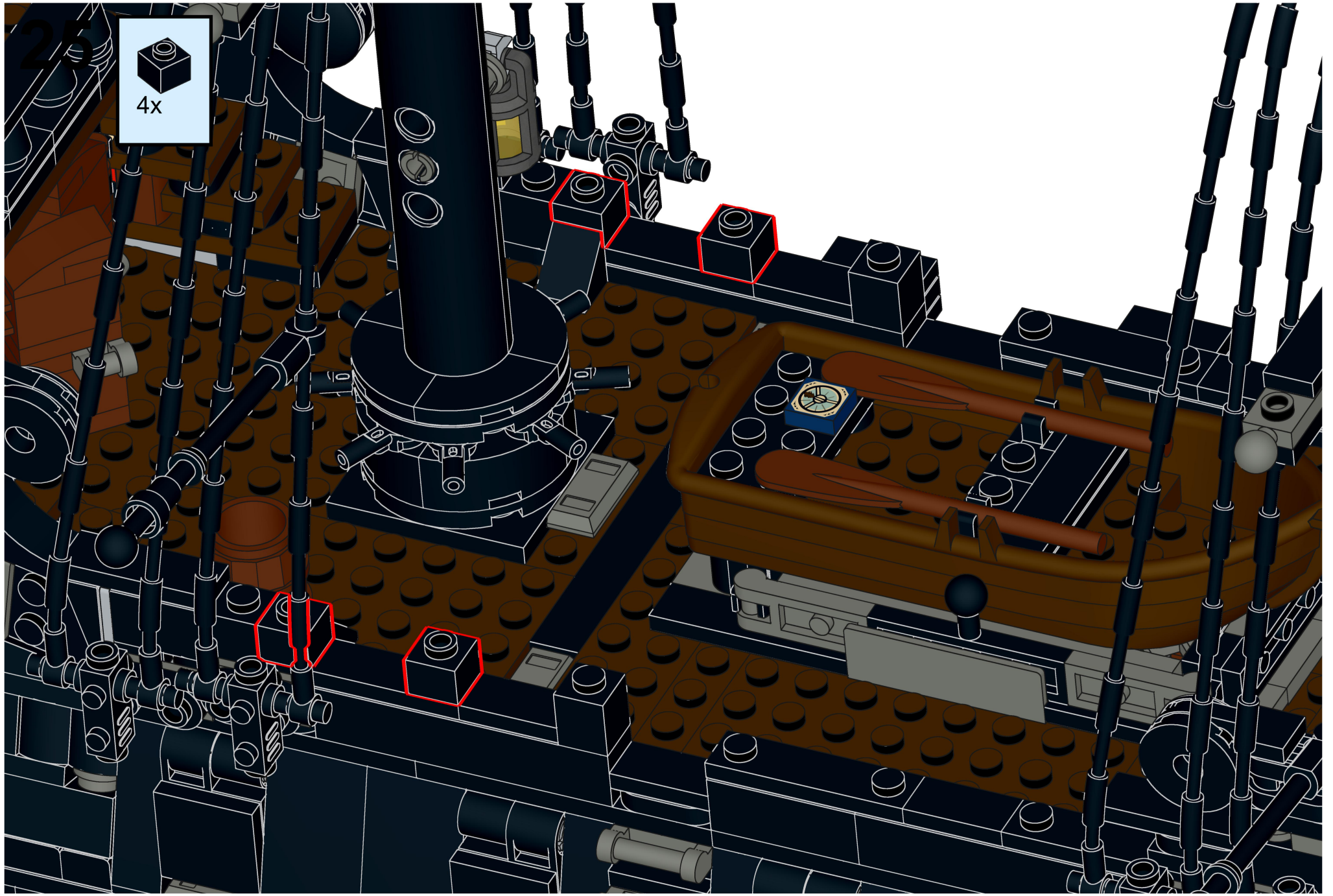

4x

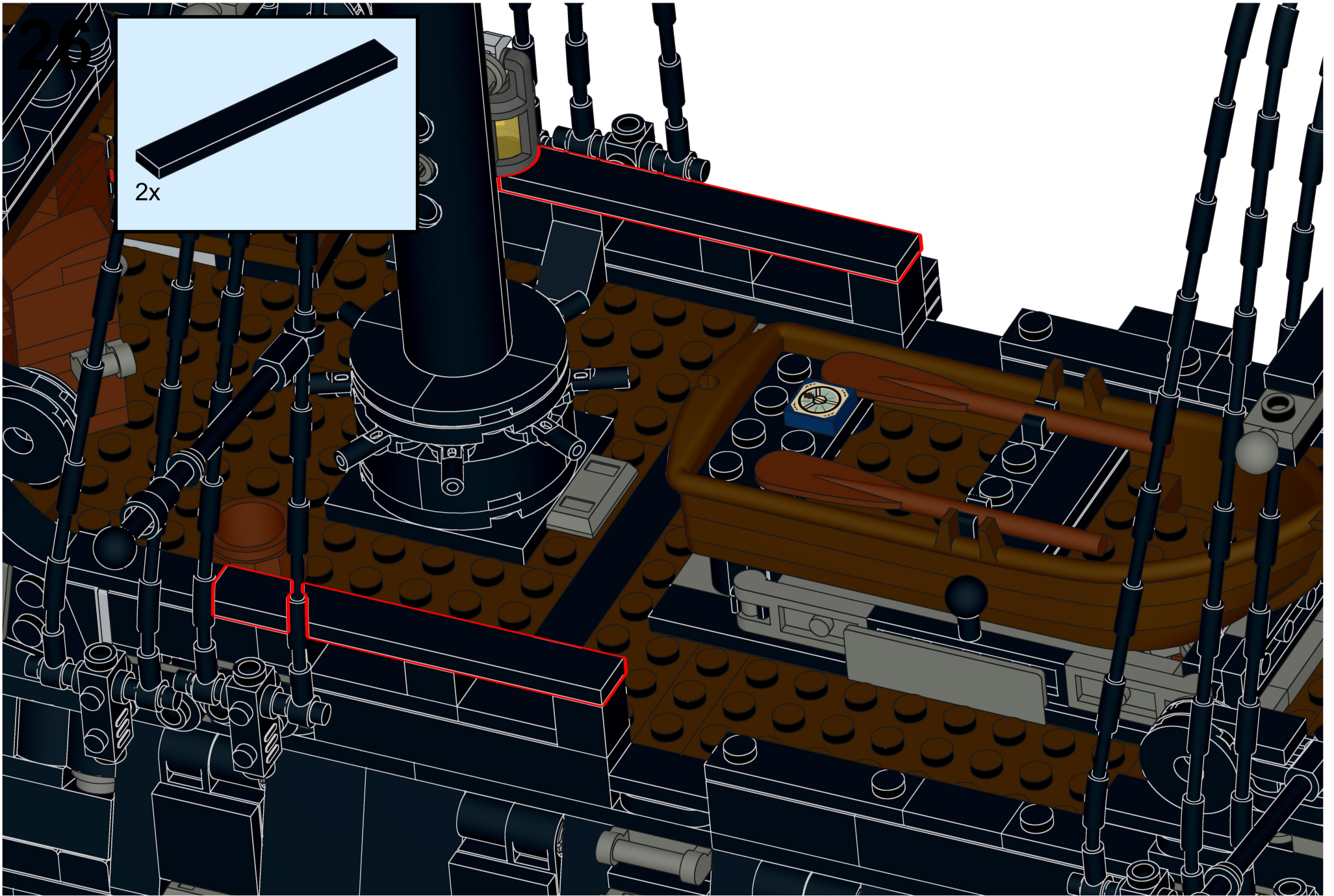

27

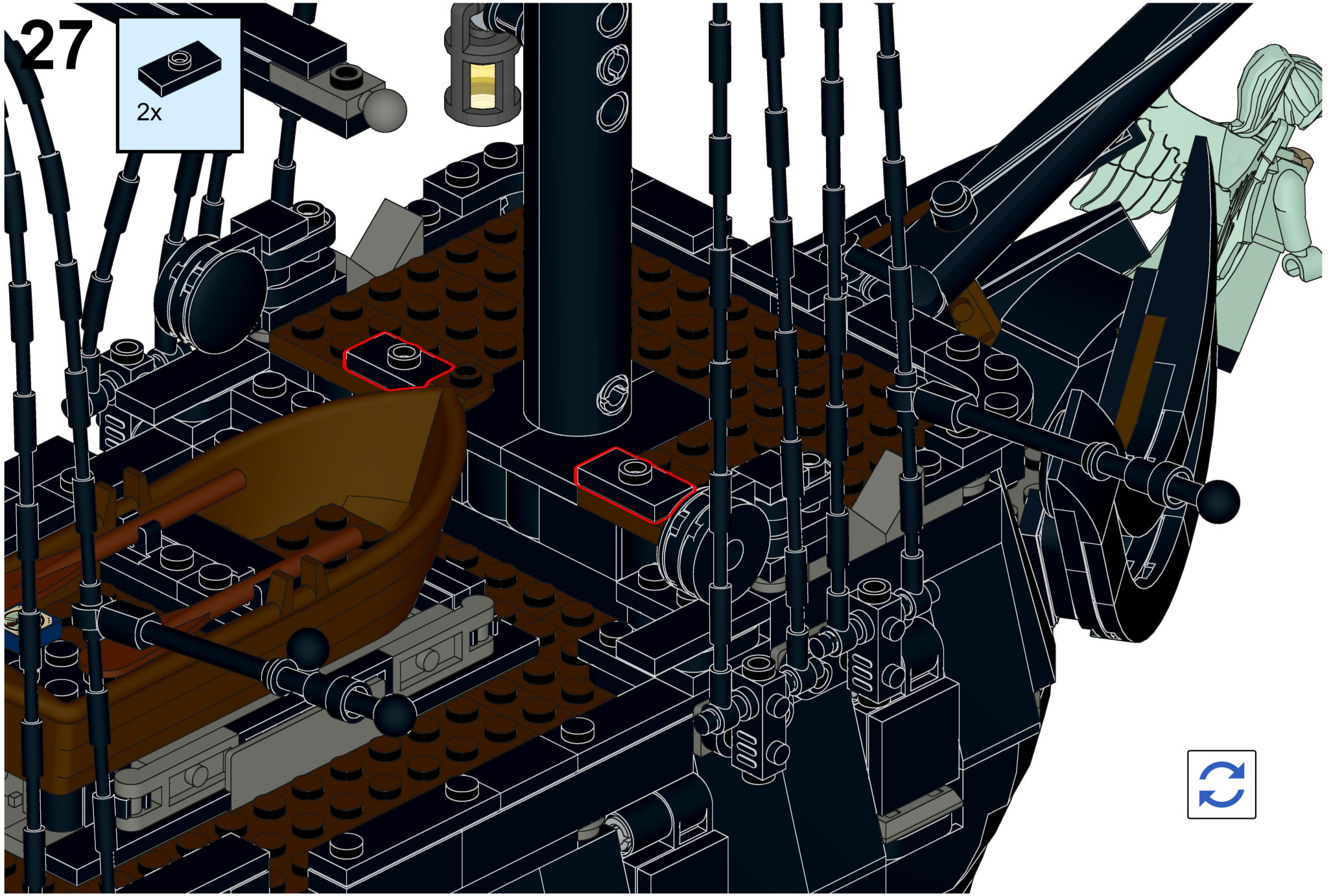
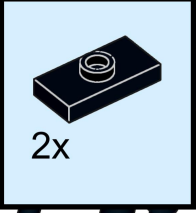

28

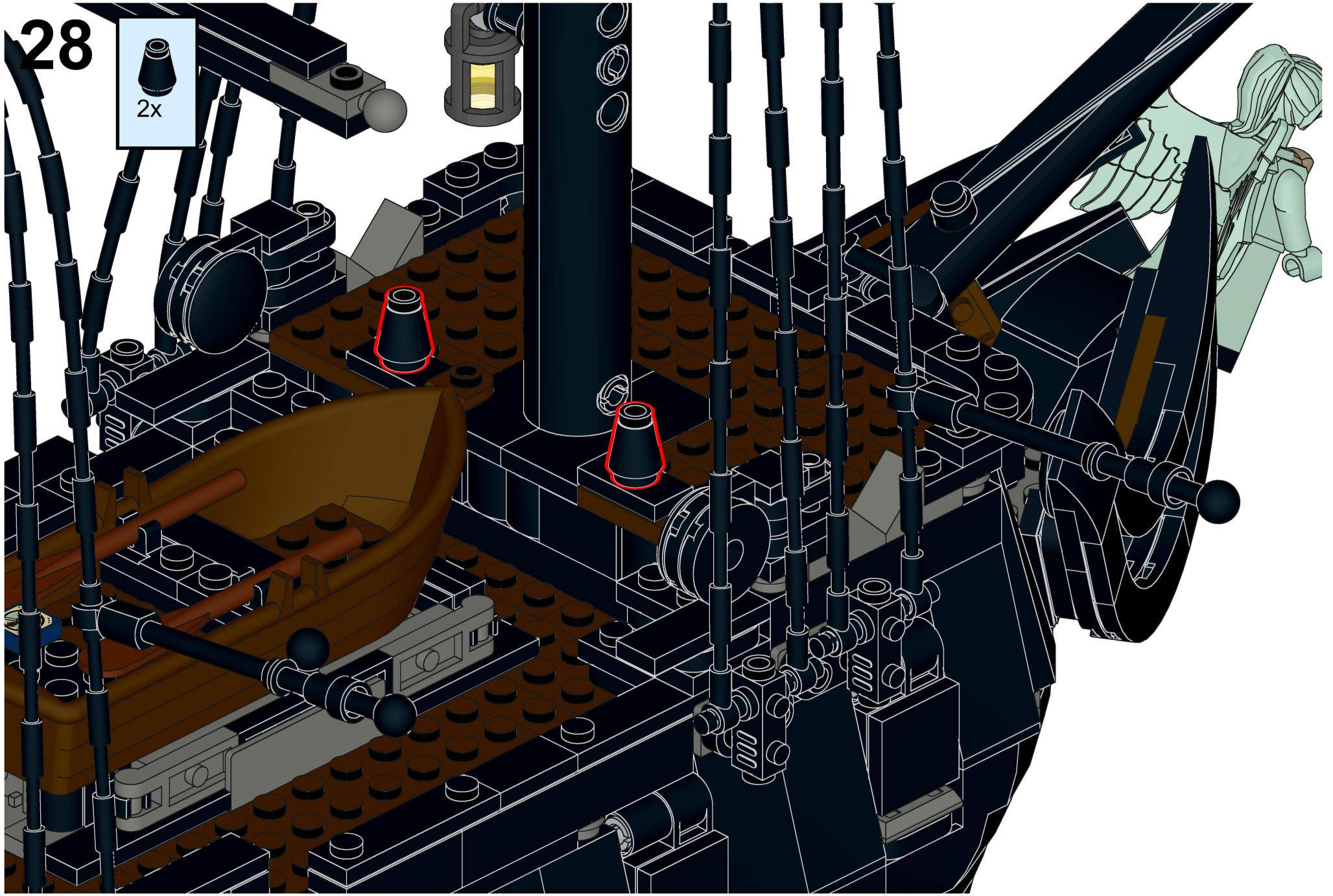

29

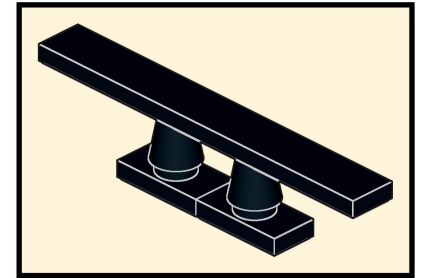
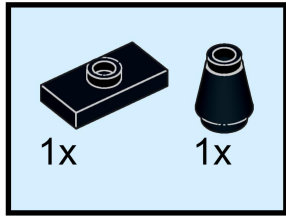

30

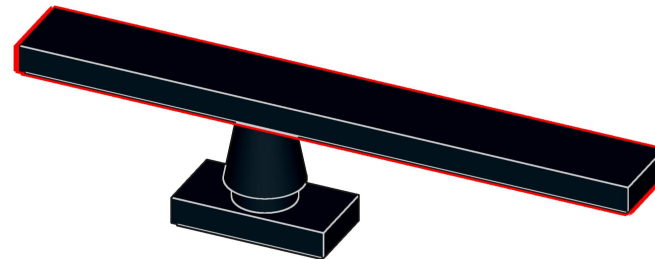
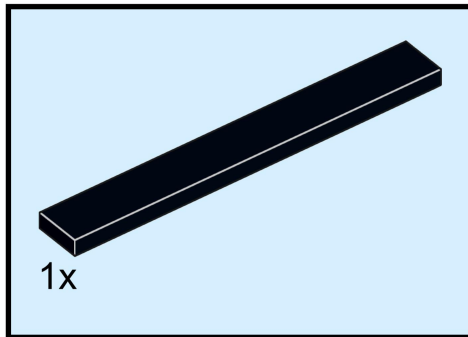

31

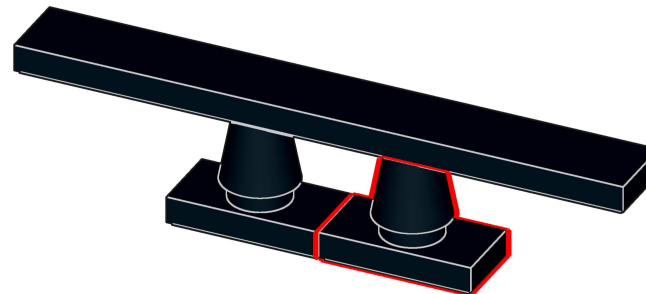
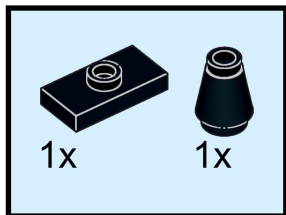

32

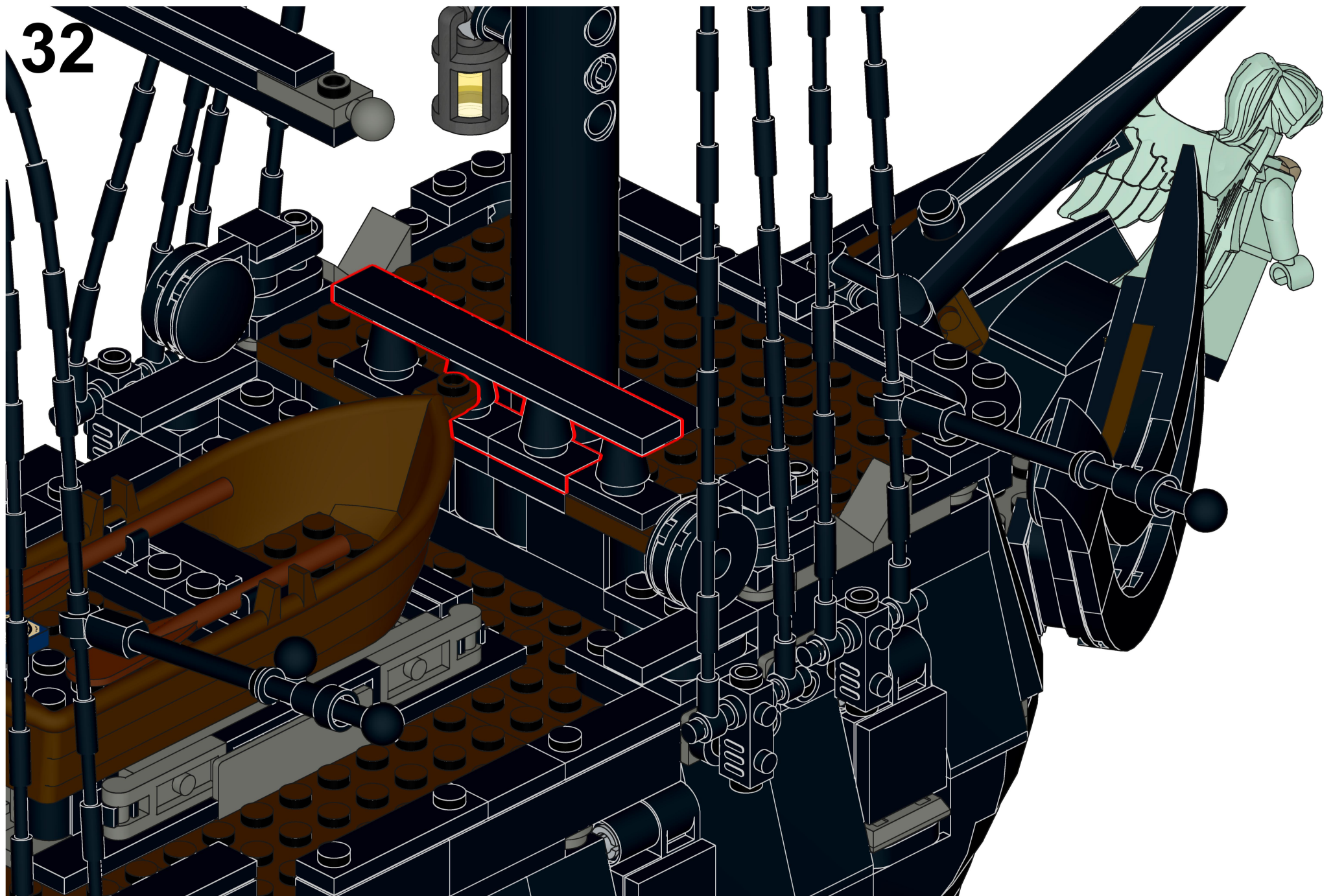

33

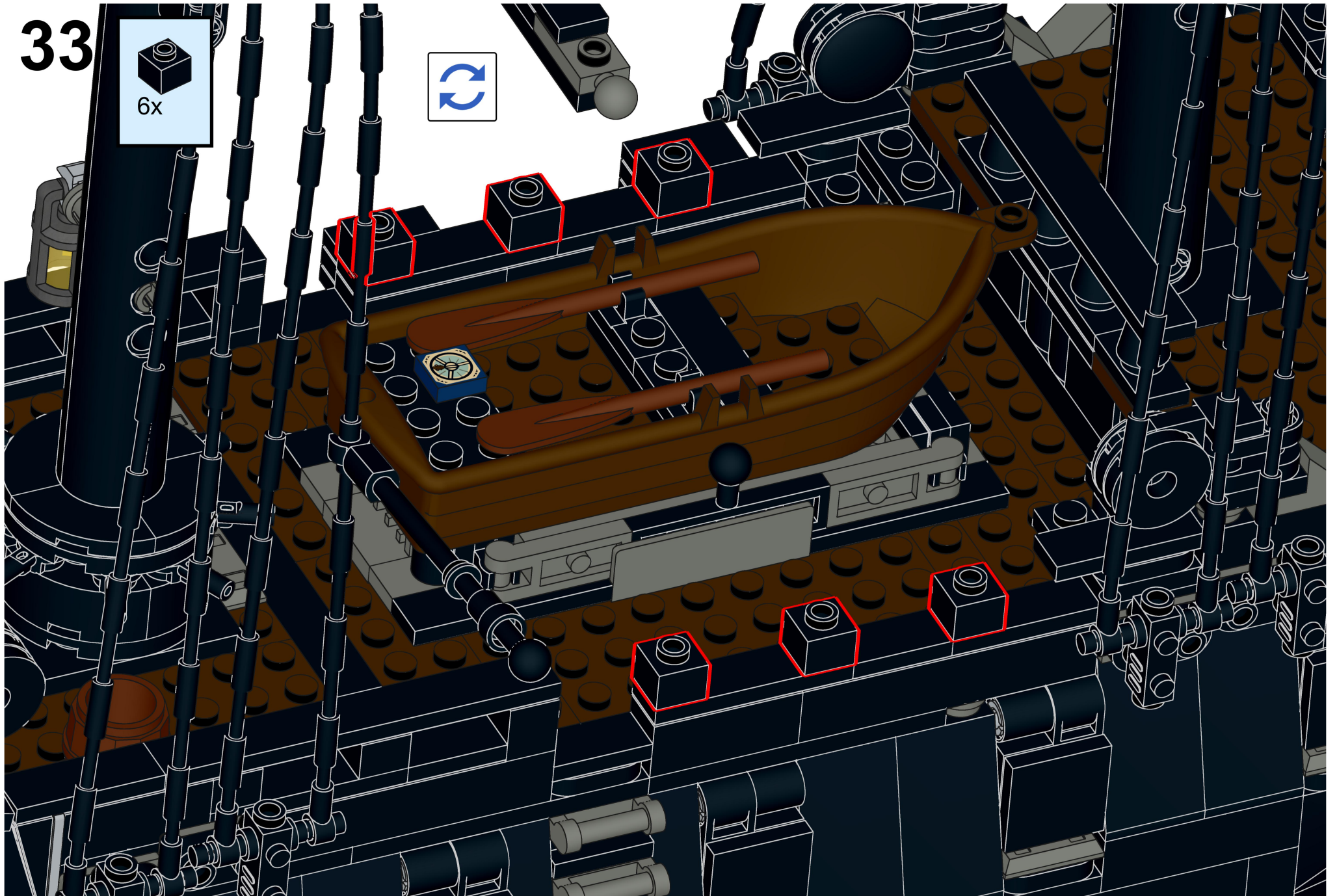
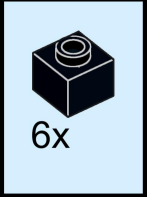

34

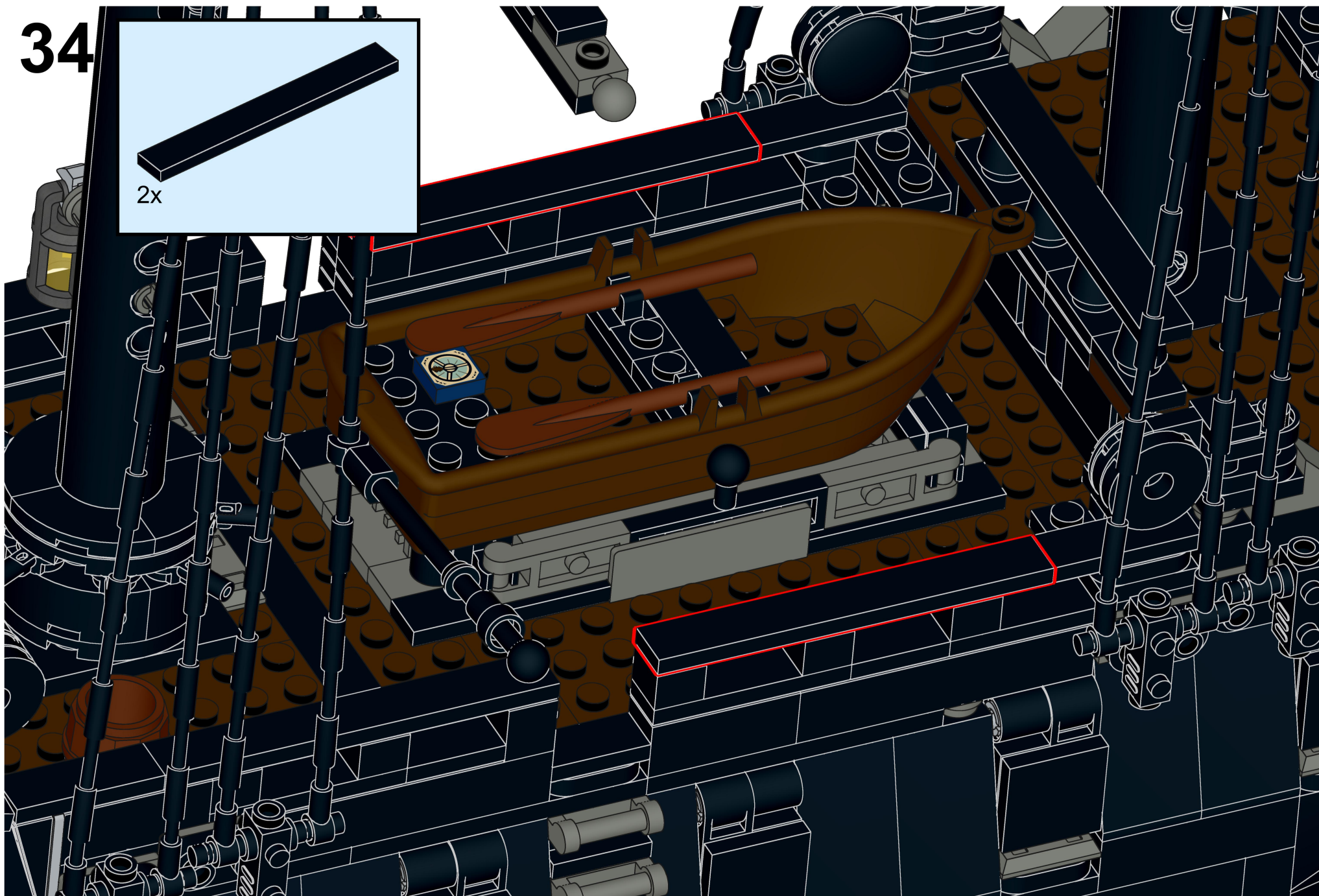
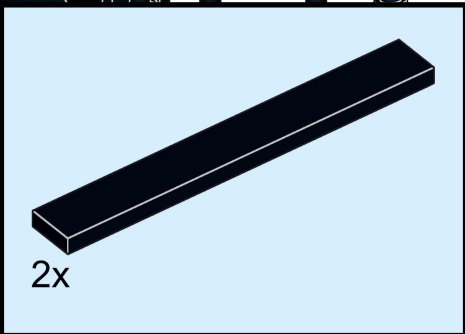

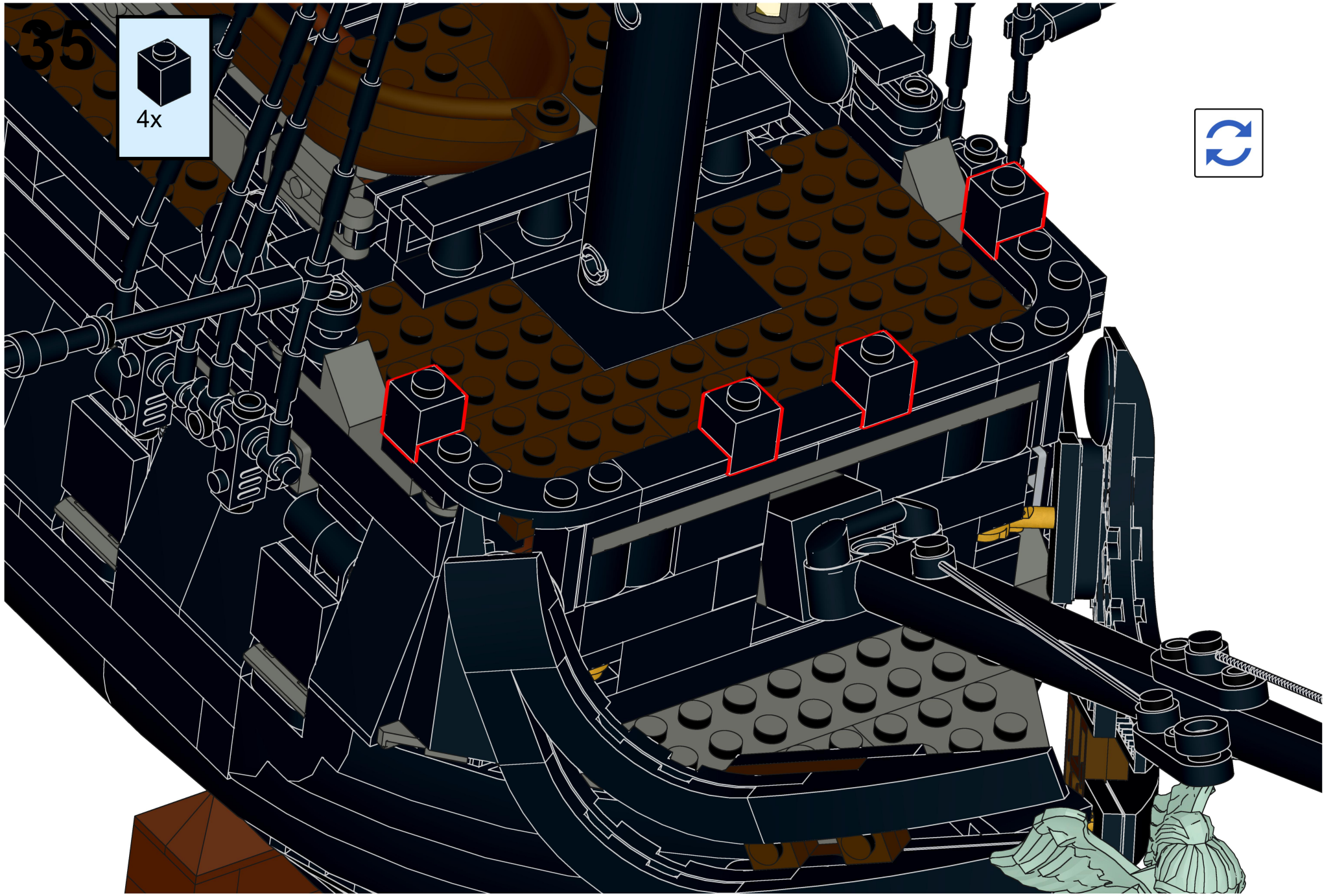

35
4x



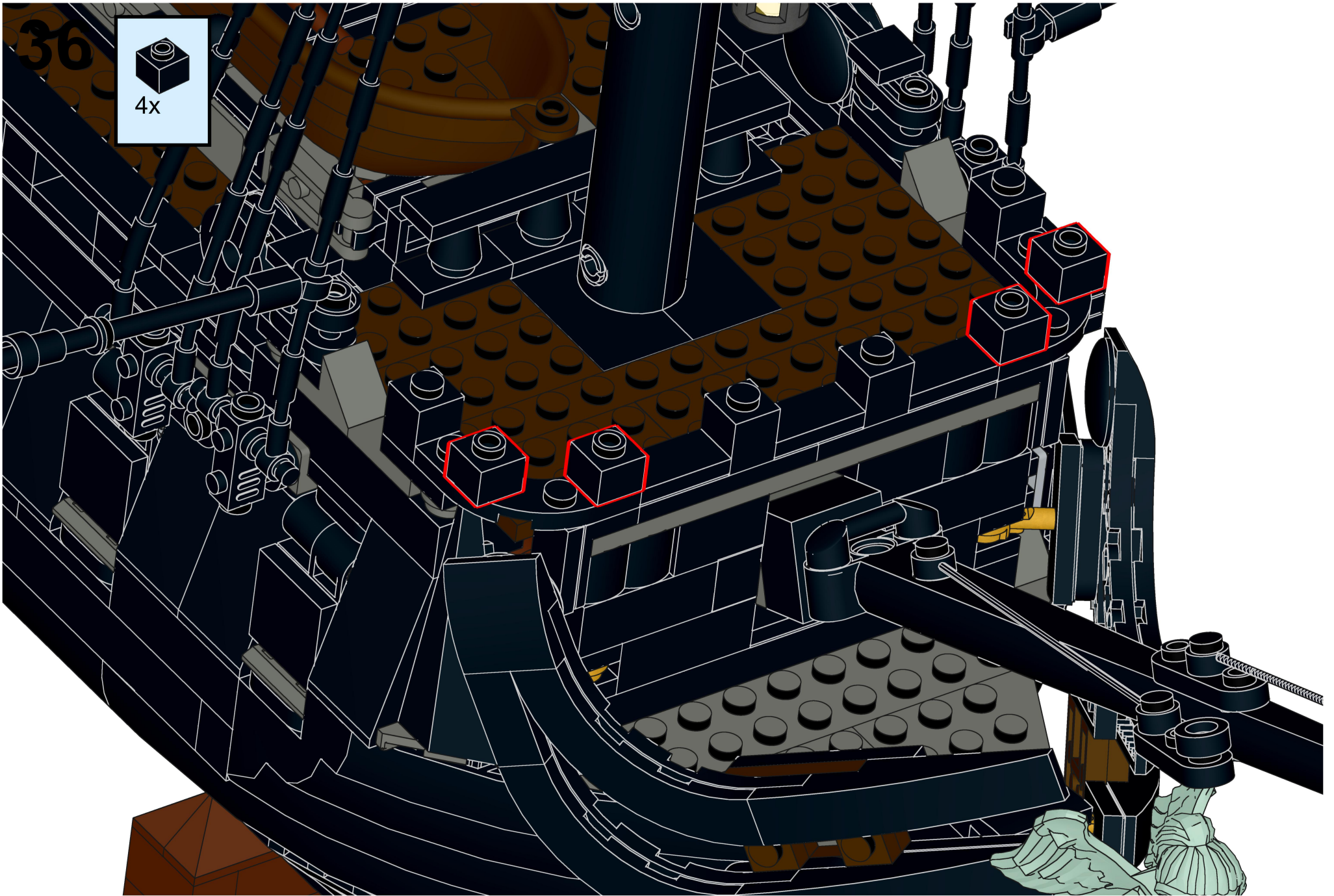

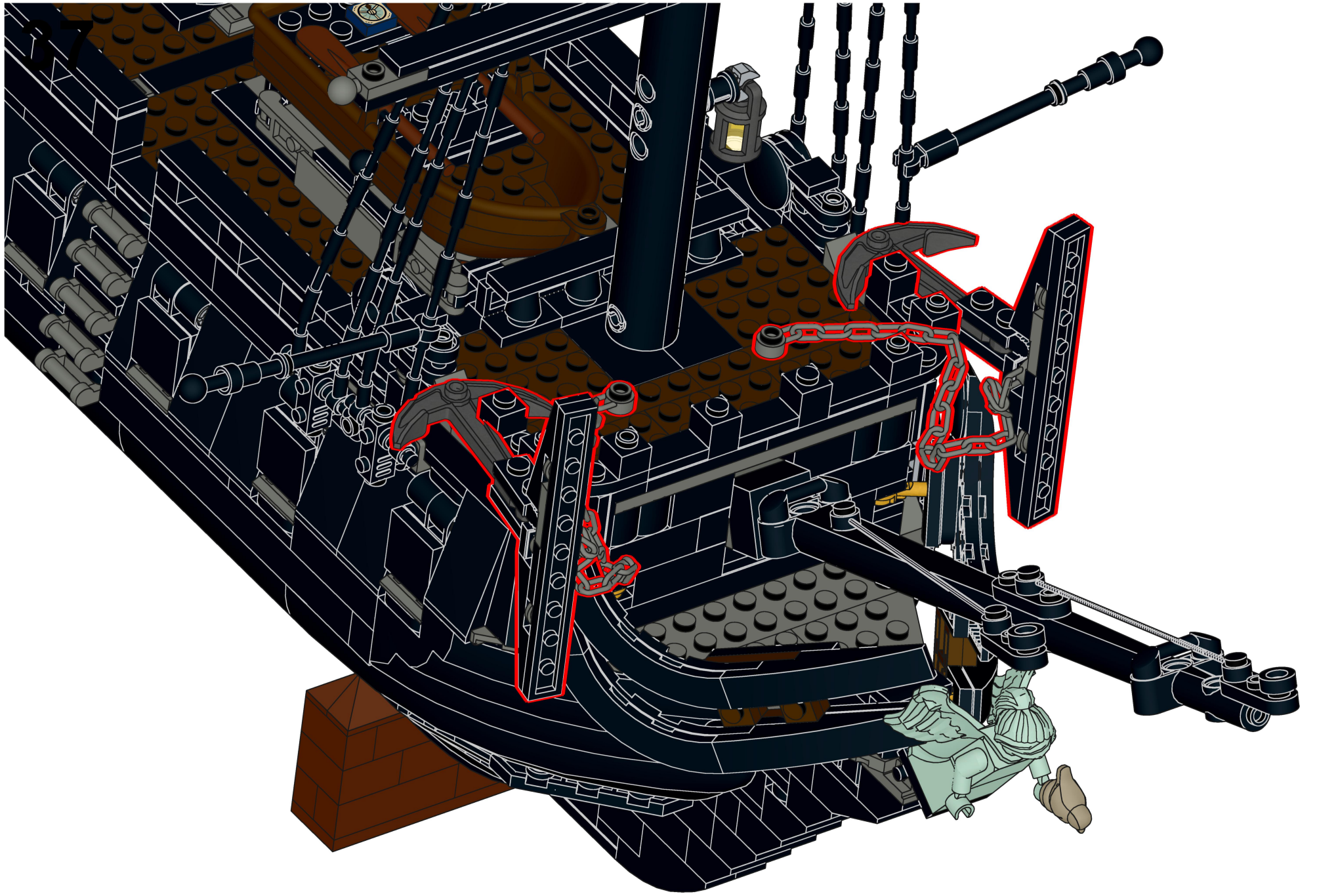

38

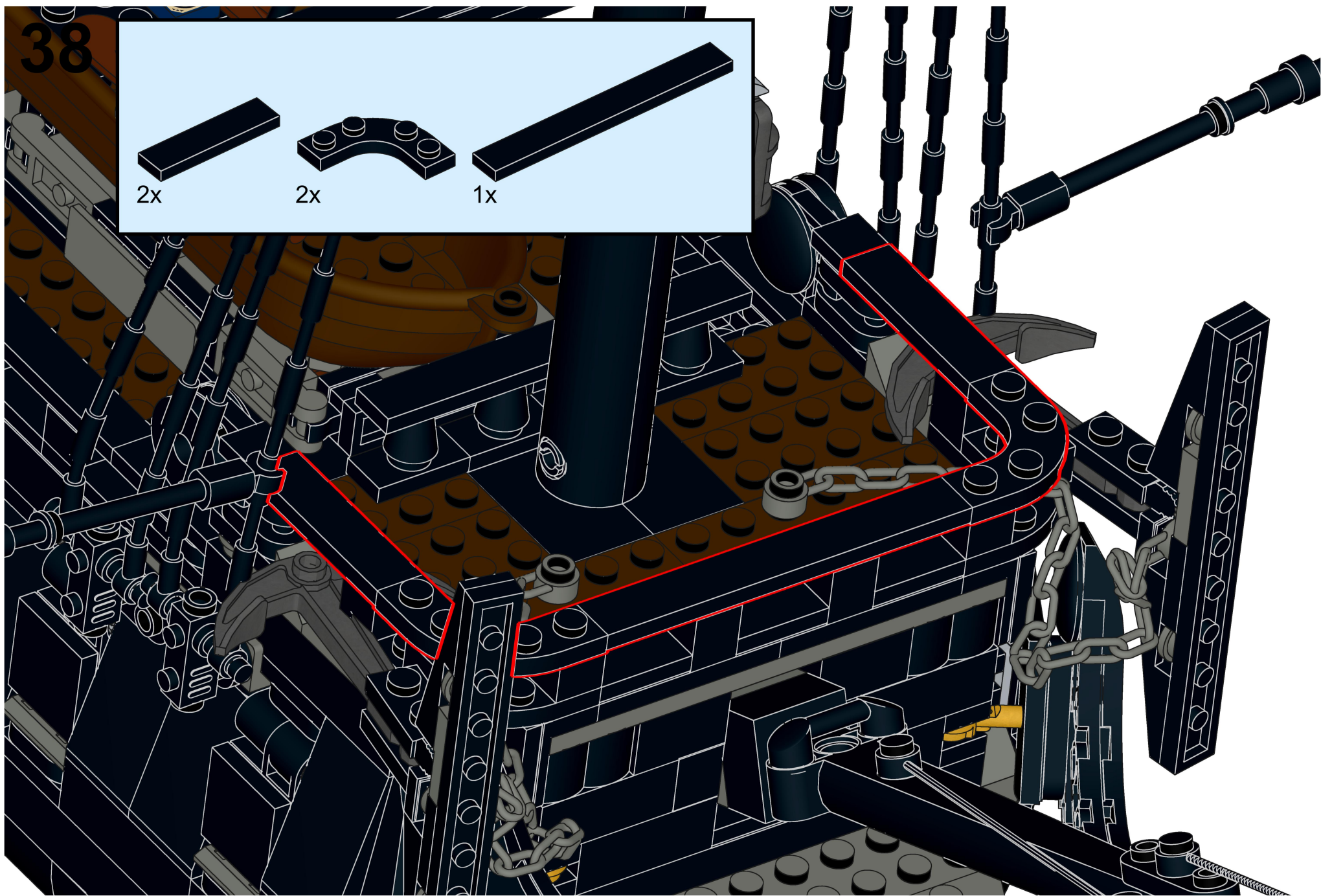
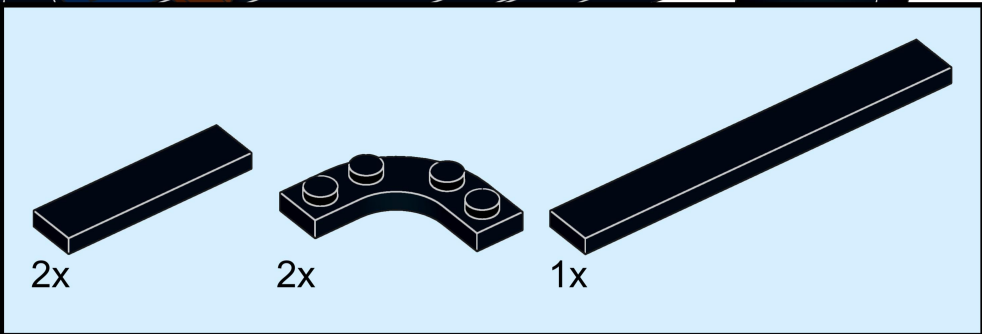

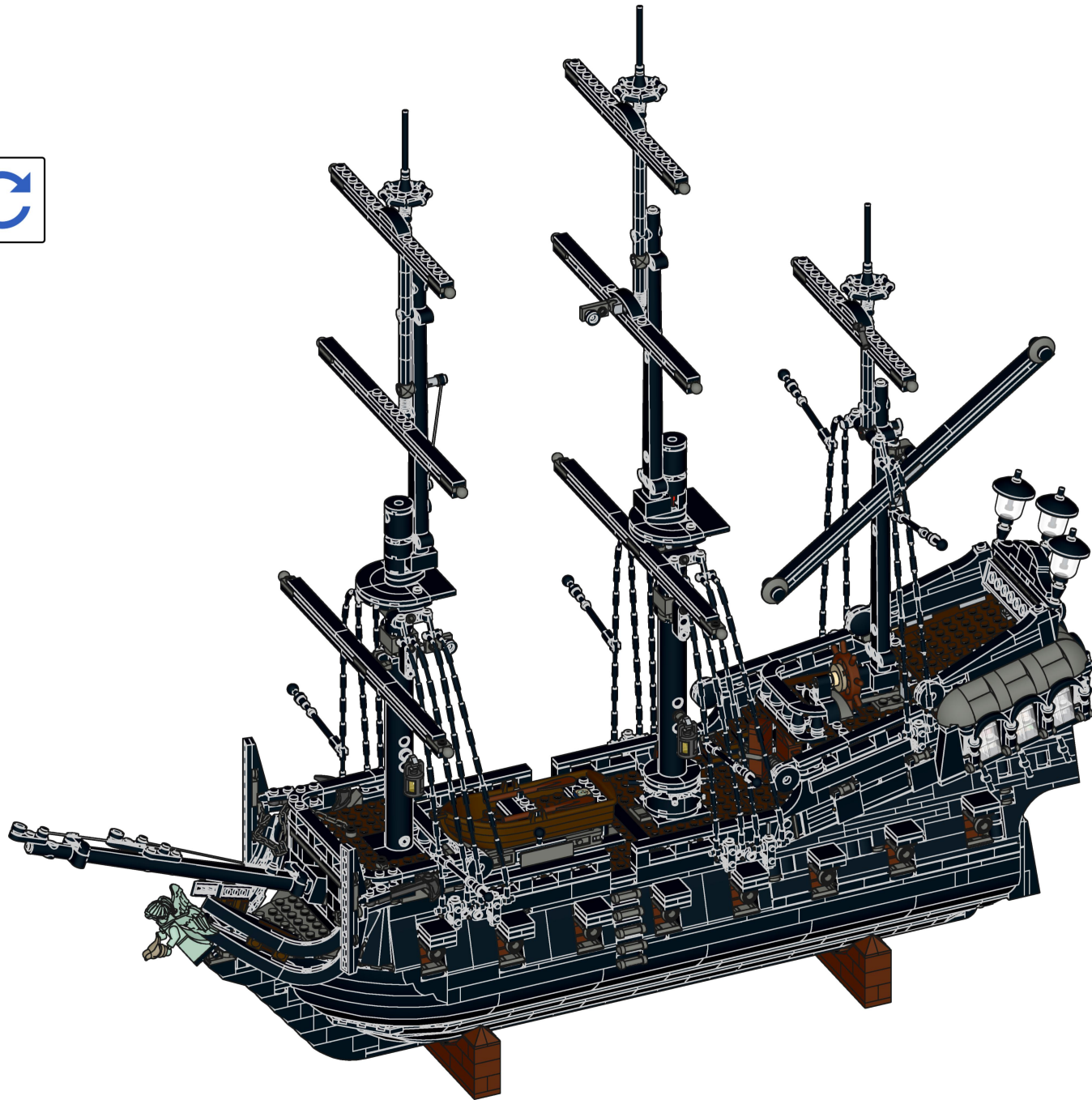

Bri  **pando**

brixpando.com